

BIOLOGY
SECTION I

Part A: 63 Multiple-Choice questions

Part B: 6 Grid-In Questions

Time—90 Minutes

Part A Directions: Each of the questions or incomplete statements below is followed by four suggested answers or completions. Select the answer that is best in each case and enter the appropriate letter in the corresponding space on the answer sheet. When you have completed part A, you should continue on to part B.

1. Membrane-bound organelles have been an important component in the evolution of complex, multicellular organisms. Which of the following best summarizes an advantage of eukaryotic cells having internal membranes?

- (A) Eukaryotic cells are able to reproduce faster because of the presence of organelles.
- (B) Some organelles, such as mitochondria and chloroplasts, are similar to prokaryotic cells in structure.
- (C) Organelles isolate specific reactions, increasing metabolic efficiency.
- (D) Compartmentalization leads to a higher mutation rate in DNA, which leads to more new species.

2. By discharging electric sparks into a laboratory chamber atmosphere that consisted of water vapor, hydrogen gas, methane, and ammonia, Stanley Miller obtained data that showed that a number of organic molecules, including many amino acids, could be synthesized. Miller was attempting to model early Earth conditions as understood in the 1950s. The results of Miller's experiments best support which of the following hypotheses?

- (A) The molecules essential to life today did not exist at the time Earth was first formed.
- (B) The molecules essential to life today could not have been carried to the primordial Earth by a comet or meteorite.
- (C) The molecules essential to life today could have formed under early Earth conditions.
- (D) The molecules essential to life today were initially self-replicating proteins that were synthesized approximately four billion years ago.

3. Simple cuboidal epithelial cells line the ducts of certain human exocrine glands. Various materials are transported into or out of the cells by diffusion. (The formula for the surface area of a cube is $6 \times S^2$, and the formula for the volume of a cube is S^3 , where S = the length of a side of the cube.)

Which of the following cube-shaped cells would be most efficient in removing waste by diffusion?

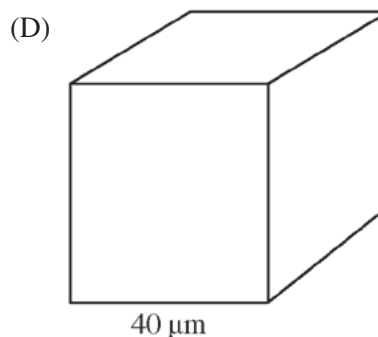
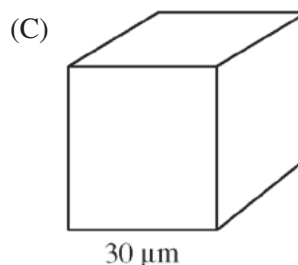
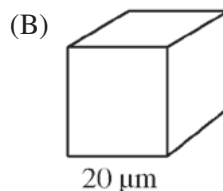
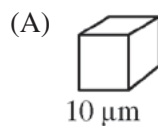

GO ON TO THE NEXT PAGE.

4. The area covered by tropical rain forest is reduced by millions of hectares per year due to agriculture and logging. Which of the following best describes a likely result of tropical rain forest deforestation?

- (A) Populations of plants and animals will decrease as more rain forest disappears, leading to a decrease in biodiversity.
- (B) An increase of soil moisture will lead to a rapid increase in new vegetation coverage.
- (C) An increase in atmospheric carbon dioxide will lead to higher levels of ultraviolet radiation reaching the surface of Earth.
- (D) More oxygen will be available to other organisms as plant numbers decrease.

5. Which of the following statements best supports the claim that organisms share fundamental processes as a result of evolution?

- (A) All organisms that are introduced into new environments have the capacity to fill vacant ecological roles.
- (B) All organisms have the ability to utilize oxygen to harness energy from the chemical breakdown of organic compounds.
- (C) All organisms share a genetic code organized into triplet codons, making it possible for one organism to express a gene from another organism.
- (D) All organisms possess structures such as chloroplasts and mitochondria within their cells that reflect past symbiotic relationships between prokaryotic precursors.

6. When DNA replicates, each strand of the original DNA molecule is used as a template for the synthesis of a second, complementary strand. Which of the following figures most accurately illustrates enzyme-mediated synthesis of new DNA at a replication fork?

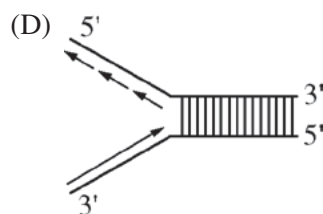
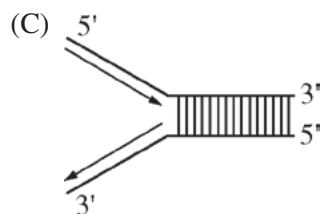
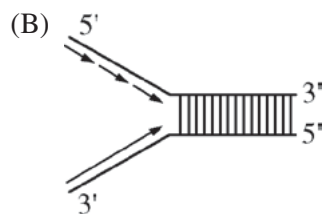
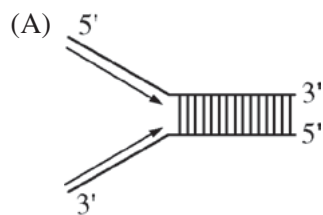

GO ON TO THE NEXT PAGE.

Questions 7-10

A biologist spent many years researching the rate of evolutionary change in the finch populations of a group of islands. It was determined that the average beak size (both length and mass) of finches in a certain population increased dramatically during an intense drought between 1981 and 1987. During the drought, there was a reduction in the number of plants producing thin-walled seeds.

7. Which of the following procedures was most likely followed to determine the change in beak size?
- (A) A few finches were trapped in 1981 and again in 1987, and their beak sizes were compared.
 - (B) The beak size in fifteen finches was measured in 1987, and the beak size in the original finches was determined by estimation.
 - (C) The beak size in a large number of finches was measured every year from 1981 to 1987.
 - (D) Finches were captured and bred in 1981, and the beak size of the offspring was measured.
8. Which of the following statements might best explain the increase in average beak size in the finch population during the drought?
- (A) Finches with bigger beaks are better able to crack thick-walled seeds and produce more surviving offspring.
 - (B) Finches with bigger beaks can attack and kill finches with smaller beaks.
 - (C) Finches with bigger beaks possess more-powerful flight muscles and are able to find more food.
 - (D) Finches that crack large seeds develop larger beaks over time.
9. Which of the following best describes the mechanism behind the change in beak size in the finch population?
- (A) The formation of two new finch species from a single parent species
 - (B) A change in gene frequencies in the finch population due to selective pressure from the environmental change
 - (C) A new allele appearing in the finch population as a result of mutation
 - (D) The achievement of dynamic equilibrium in the finch population as a result of homeostasis
10. The biologist discovered that from 1988 to 1993, the average beak size declined to pre-1981 levels. The reversal in beak size from 1988 to 1993 was most likely related to which of the following events?
- (A) A loss of food supply for the finches
 - (B) The end of the drought
 - (C) An increase in drought conditions
 - (D) An increase in predators consuming finches

GO ON TO THE NEXT PAGE.

11. Which of the following correctly illustrates a dipeptide and an amino acid in the optimal position to form a tripeptide?

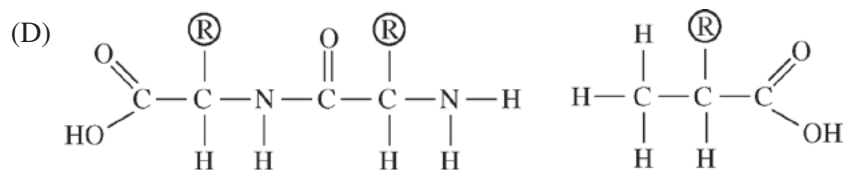
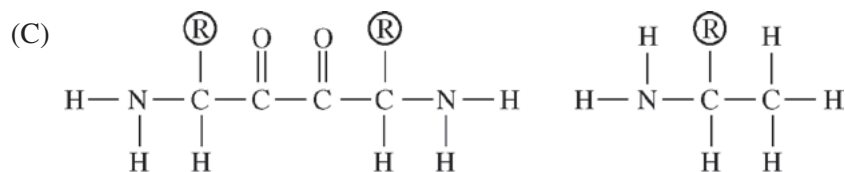
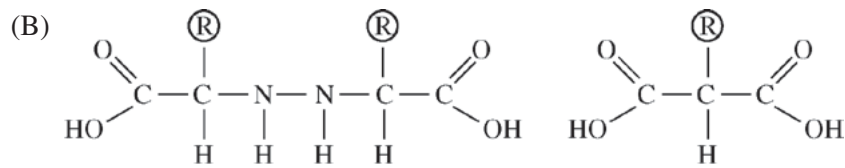
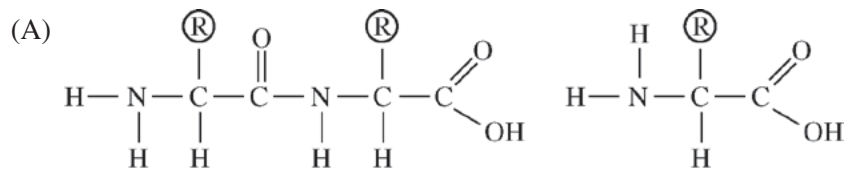

GO ON TO THE NEXT PAGE.

12. The following is a food web for a meadow habitat that occupies 25.6 km^2 . The primary producers' biomass is uniformly distributed throughout the habitat and totals $1,500 \text{ kg/km}^2$.

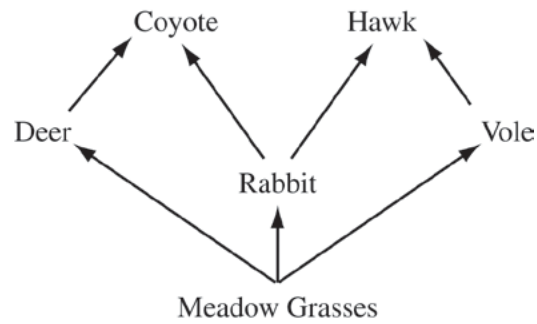

Developers have approved a project that will permanently reduce the primary producers' biomass by 50 percent and remove all rabbits and deer.

Which of the following is the most likely result at the completion of the project?

- (A) The biomass of coyotes will be 6 kg, and the biomass of hawks will be 0.5 kg.
- (B) The biomass of coyotes will be dramatically reduced.
- (C) The coyotes will switch prey preferences and outcompete the hawks.
- (D) There will be 50 percent fewer voles and 90 percent fewer hawks.

GO ON TO THE NEXT PAGE.

Segment 1:

5' - ATATGAGTAGT - 3'
3' - TATACTCATCA - 5'

Segment 2:

5' - GCGCAGACGAC - 3'
3' - CGCGTCTGCTG - 5'

13. The sequences for two short fragments of DNA are shown above. Which of the following is one way in which these two segments would differ?
- (A) Segment 1 would not code for mRNA because both strands have T, a base not found in RNA.
 - (B) Segment 1 would be more soluble in water than segment 2 because it has more phosphate groups.
 - (C) Segment 1 would become denatured at a lower temperature than would segment 2 because A-T base pairs have two hydrogen bonds whereas G-C base pairs have three.
 - (D) Segment 1 must be from a prokaryote because it has predominantly A-T base pairs.

GO ON TO THE NEXT PAGE.

14. A pathogenic bacterium has been engulfed by a phagocytic cell as part of the nonspecific (innate) immune response. Which of the following illustrations best represents the response?

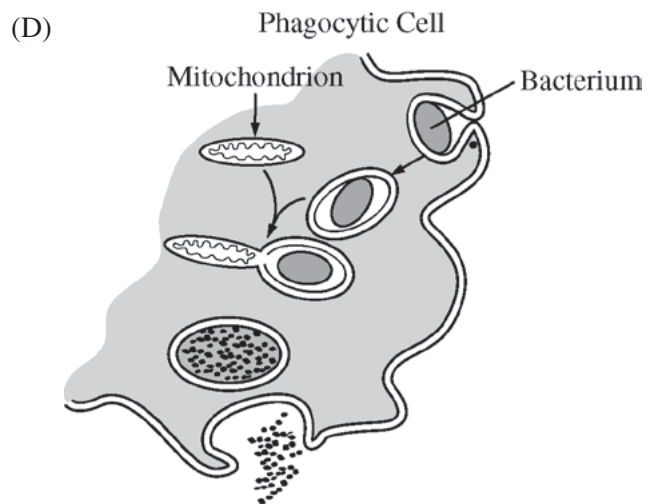
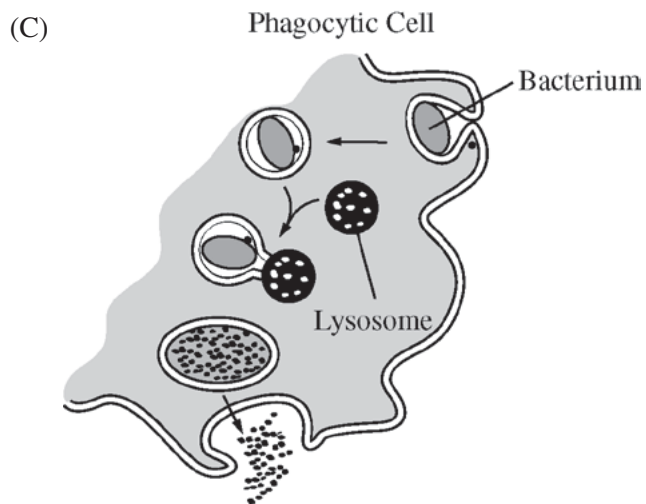
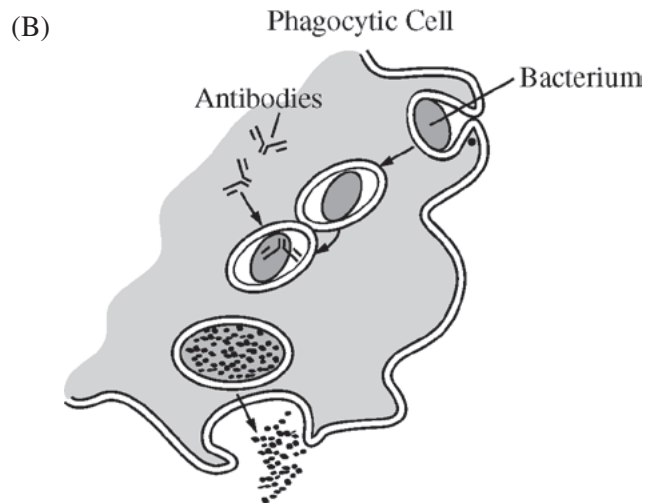
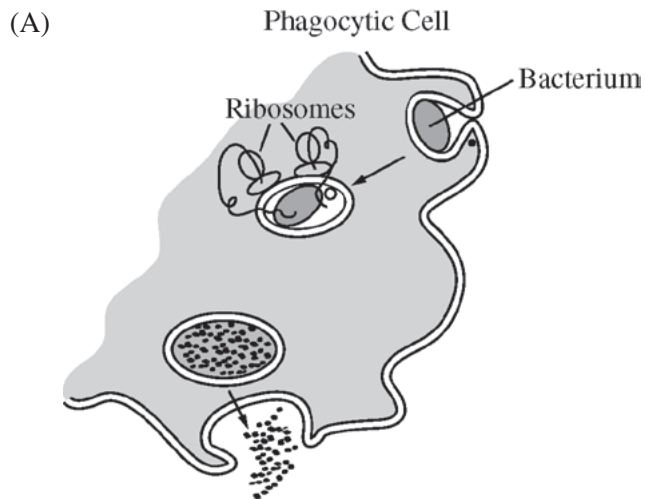

GO ON TO THE NEXT PAGE.

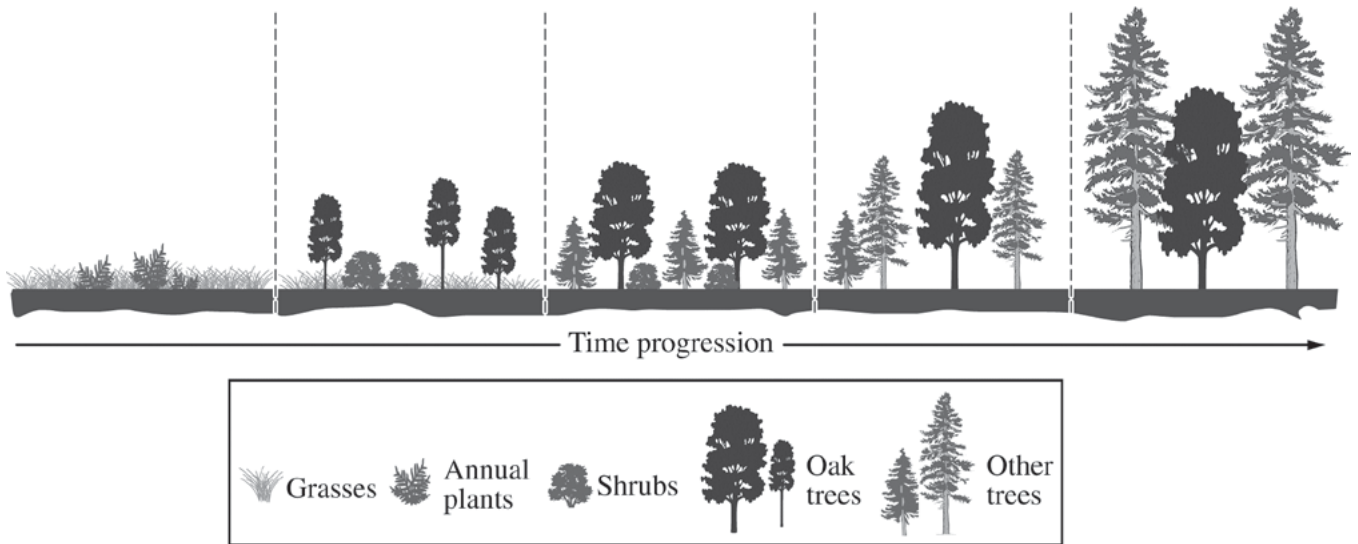

15. The diagram above shows the progression of ecological events after a fire in a particular ecosystem. Based on the diagram, which of the following best explains why the oak trees are later replaced by other trees?
- (A) Eventually the other trees grow taller than the oak trees and form a dense canopy that shades the understory.
 - (B) Oak trees alter the pH of the soil, making the forest better suited for shrubs and other trees.
 - (C) Roots of shrubs proliferate in the soil of the forest and prevent the oak trees from obtaining water.
 - (D) Oak trees succumb to environmental pollutants more readily than do either the shrubs or the other trees.

GO ON TO THE NEXT PAGE.

16. Lactose digestion in *E. coli* begins with its hydrolysis by the enzyme β -galactosidase. The gene encoding β -galactosidase, *lacZ*, is part of a coordinately regulated operon containing other genes required for lactose utilization.

Which of the following figures correctly depicts the interactions at the *lac* operon when lactose is NOT being utilized? (The legend below defines the shapes of the molecules illustrated in the options.)

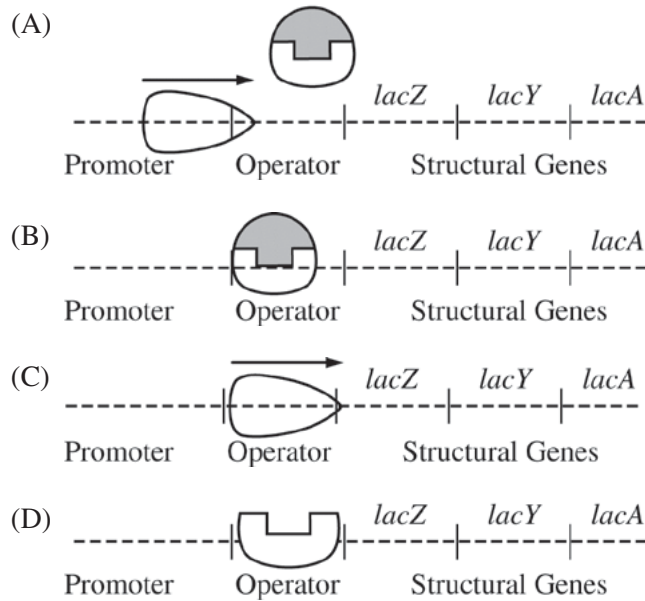

GO ON TO THE NEXT PAGE.

Questions 17-19

An experiment to measure the rate of respiration in crickets and mice at 10°C and 25°C was performed using a respirometer, an apparatus that measures changes in gas volume. Respiration was measured in mL of O₂ consumed per gram of organism over several five-minute trials and the following data were obtained.

Organism	Temperature (°C)	Average respiration (mL O ₂ /g/min)
Mouse	10	0.0518
Mouse	25	0.0321
Cricket	10	0.0013
Cricket	25	0.0038

17. During aerobic cellular respiration, oxygen gas is consumed at the same rate as carbon dioxide gas is produced. In order to provide accurate volumetric measurements of oxygen gas consumption, the experimental setup should include which of the following?
- (A) A substance that removes carbon dioxide gas
 - (B) A plant to produce oxygen
 - (C) A glucose reserve
 - (D) A valve to release excess water
18. According to the data, the mice at 10°C demonstrated greater oxygen consumption per gram of tissue than did the mice at 25°C. This is most likely explained by which of the following statements?
- (A) The mice at 10°C had a higher rate of ATP production than the mice at 25°C.
 - (B) The mice at 10°C had a lower metabolic rate than the mice at 25°C.
 - (C) The mice at 25°C weighed less than the mice at 10°C.
 - (D) The mice at 25°C were more active than the mice at 10°C.
19. According to the data, the crickets at 25°C have greater oxygen consumption per gram of tissue than do the crickets at 10°C. This trend in oxygen consumption is the opposite of that in the mice. The difference in trends in oxygen consumption among crickets and mice is due to their
- (A) relative size
 - (B) mode of nutrition
 - (C) mode of internal temperature regulation
 - (D) mode of ATP production

GO ON TO THE NEXT PAGE.

20. The FtsZ protein is present in prokaryotes and in chloroplasts. The protein is structurally and functionally similar to tubulin proteins of eukaryotic cells. Which of the following is a likely conclusion to draw from this information?
- (A) FtsZ and tubulin proteins were both present in a common ancestor.
 - (B) Microtubules are involved in the mechanics of photosynthesis.
 - (C) Tubulin genes are evolutionarily derived from the gene that codes for the FtsZ protein.
 - (D) The sequences of the genes encoding the FtsZ and tubulin proteins are identical.
21. In most freshwater fish, nitrogenous waste is primarily excreted as ammonia, which is highly soluble in water and is toxic at low concentrations. In terrestrial mammals, ammonia is converted to urea before it is excreted. Urea is also highly soluble in water but is less toxic than ammonia at low concentrations. Which of the following best explains why freshwater fish do not convert ammonia to urea for excretion?
- (A) The metabolic pathways of fish do not normally involve nitrogen consumption.
 - (B) The dilution of ammonia by direct excretion into freshwater conserves energy.
 - (C) Ammonia is concentrated in tissues, where it is stored prior to excretion.
 - (D) The nitrogen in ammonia is recycled for use in protein and nucleotide synthesis.
22. During the infection cycle for a typical retrovirus, such as HIV, which uses RNA as genetic material, the genetic variation in the resulting population of new virus particles is very high because of
- (A) damage to the virus particle from envelope loss during infection
 - (B) errors introduced in the DNA molecule through reverse transcription
 - (C) errors in the protein molecules produced in translation
 - (D) recombination of the genomes of free virus particles

GO ON TO THE NEXT PAGE.

23. A sample of human blood was placed in a test tube containing a physiological saline solution (0.9% sodium chloride). This type of solution is often used intravenously to quickly rehydrate patients. A drop of the blood from the test tube was placed on a slide and red blood cells (RBCs) were observed under a microscope. Three possible outcomes are diagrammed below.

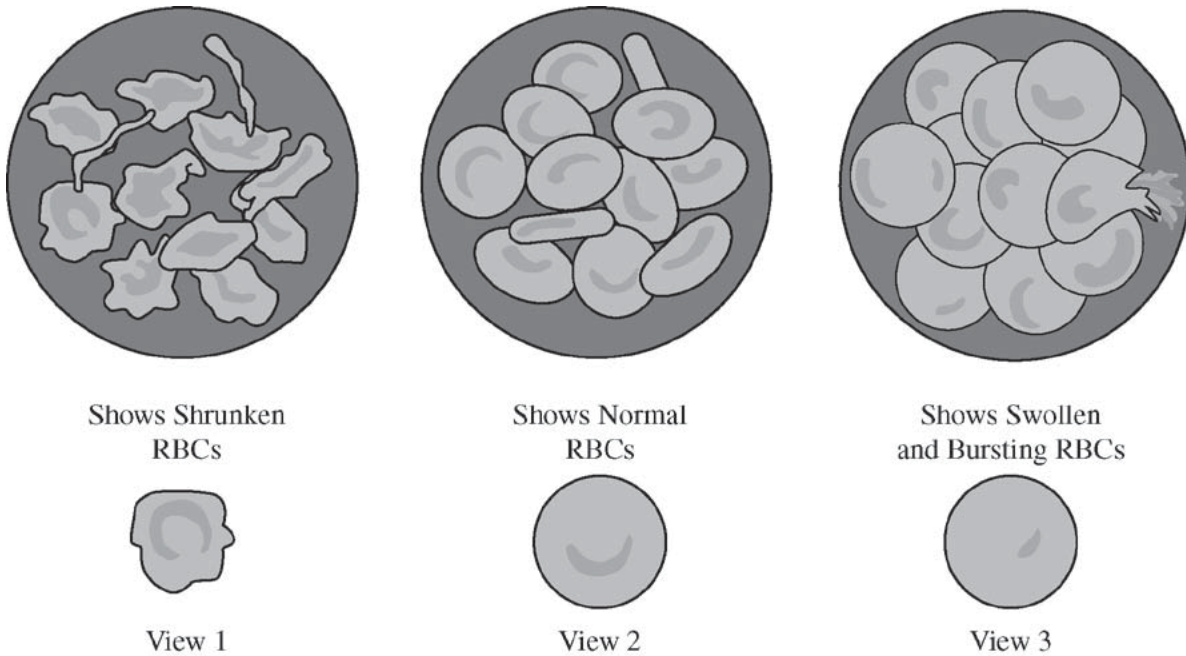

Which of the following best predicts which diagrammed microscope view the laboratory worker would see and best explains why?

- (A) View 1 because RBC membranes are freely permeable to water
- (B) View 2 because the RBCs use energy to allow sodium entry and to pump water out
- (C) View 2 because the rate of water movement into the RBCs equals the rate of water movement out of the cells
- (D) View 3 because the sodium-potassium pumps in the RBC membranes use energy to keep the sodium out but allow water to freely flow into the cells

GO ON TO THE NEXT PAGE.

24. Which of the following statements most directly supports the claim that different species of organisms use different metabolic strategies to meet their energy requirements for growth, reproduction, and homeostasis?
- (A) During cold periods pond-dwelling animals can increase the number of unsaturated fatty acids in their cell membranes while some plants make antifreeze proteins to prevent ice crystal formation in tissues.
 - (B) Bacteria lack introns while many eukaryotic genes contain many of these intervening sequences.
 - (C) Carnivores have more teeth that are specialized for ripping food while herbivores have more teeth that are specialized for grinding food.
 - (D) Plants generally use starch molecules for storage while animals use glycogen and fats for storage.

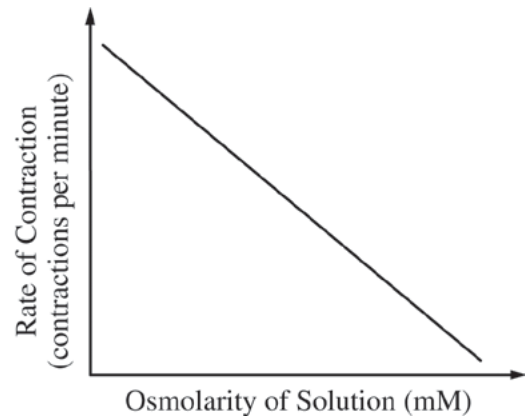

25. Paramecia are unicellular protists that have contractile vacuoles to remove excess intracellular water. In an experimental investigation, paramecia were placed in salt solutions of increasing osmolarity. The rate at which the contractile vacuole contracted to pump out excess water was determined and plotted against osmolarity of the solutions, as shown in the graph. Which of the following is the correct explanation for the data?
- (A) At higher osmolarity, lower rates of contraction are required because more salt diffuses into the paramecia.
 - (B) The contraction rate increases as the osmolarity decreases because the amount of water entering the paramecia by osmosis increases.
 - (C) The contractile vacuole is less efficient in solutions of high osmolarity because of the reduced amount of ATP produced from cellular respiration.
 - (D) In an isosmotic salt solution, there is no diffusion of water into or out of the paramecia, so the contraction rate is zero.

GO ON TO THE NEXT PAGE.

Questions 26-29

A student placed 20 tobacco seeds of the same species on moist paper towels in each of two petri dishes. Dish A was wrapped completely in an opaque cover to exclude all light. Dish B was not wrapped. The dishes were placed equidistant from a light source set to a cycle of 14 hours of light and 10 hours of dark. All other conditions were the same for both dishes. The dishes were examined after 7 days and the opaque cover was permanently removed from dish A. Both dishes were returned to the light and examined again at 14 days. The following data were obtained.

	Dish A		Dish B	
	Day 7 Covered	Day 14 Uncovered	Day 7 Uncovered	Day 14 Uncovered
Germinated seeds	12	20	20	20
Green-leaved seedlings	0	14	15	15
Yellow-leaved seedlings	12	6	5	5
Mean stem length below first set of leaves	8 mm	9 mm	3 mm	3 mm

26. According to the results of this experiment, germination of tobacco seeds during the first week is
- increased by exposure to light
 - unaffected by light intensity
 - prevented by paper towels
 - accelerated in green-leaved seedlings
27. The most probable cause for the difference in mean stem length between plants in dish A and plants in dish B is which of the following?
- Shortening of cells in the stem in response to the lack of light
 - Elongation of seedlings in response to the lack of light
 - Enhancement of stem elongation by light
 - Genetic differences between the seeds
28. Which of the following best supports the hypothesis that the difference in leaf color is genetically controlled?
- The number of yellow-leaved seedlings in dish A on day 7
 - The number of germinated seeds in dish A on days 7 and 14
 - The death of all the yellow-leaved seedlings
 - The existence of yellow-leaved seedlings as well as green-leaved ones on day 14 in dish B
29. Additional observations were made on day 21, and no yellow-leaved seedlings were found alive in either dish. This is most likely because
- yellow-leaved seedlings were unable to absorb water from the paper towels
 - taller green-leaved seedlings blocked the light and prevented photosynthesis
 - yellow-leaved seedlings were unable to convert light energy to chemical energy
 - a higher rate of respiration in yellow-leaved seedlings depleted their stored nutrients

GO ON TO THE NEXT PAGE.

30. Arctic foxes typically have a white coat in the winter. In summer, when there is no snow on the ground, the foxes typically have a darker coat. Which of the following is most likely responsible for the seasonal change in coat color?
- (A) The decrease in the amount of daylight in winter causes a change in gene expression, which results in the foxes growing a lighter-appearing coat.
 - (B) The diet of the foxes in summer lacks a particular nutrient, which causes the foxes to lose their white coat and grow a darker-colored coat.
 - (C) Competition for mates in the spring causes each fox to increase its camouflage with the environment by producing a darker-appearing coat.
 - (D) The lower temperatures in winter denature the pigment molecules in the arctic fox coat, causing the coat to become lighter in color.
31. The endocrine system incorporates feedback mechanisms that maintain homeostasis. Which of the following demonstrates negative feedback by the endocrine system?
- (A) During labor, the fetus exerts pressure on the uterine wall, inducing the production of oxytocin, which stimulates uterine wall contraction. The contractions cause the fetus to further push on the wall, increasing the production of oxytocin.
 - (B) After a meal, blood glucose levels become elevated, stimulating beta cells of the pancreas to release insulin into the blood. Excess glucose is then converted to glycogen in the liver, reducing blood glucose levels.
 - (C) At high elevation, atmospheric oxygen is more scarce. In response to signals that oxygen is low, the brain decreases an individual's rate of respiration to compensate for the difference.
 - (D) A transcription factor binds to the regulatory region of a gene, blocking the binding of another transcription factor required for expression.

GO ON TO THE NEXT PAGE.

32. Five new species of bacteria were discovered in Antarctic ice core samples. The nucleotide (base) sequences of rRNA subunits were determined for the new species. The table below shows the number of nucleotide differences between the species.

NUCLEOTIDE DIFFERENCES

Species	1	2	3	4	5
1	–	3	19	18	27
2		–	19	18	26
3			–	1	27
4				–	27
5					–

Which of the following phylogenetic trees is most consistent with the data?

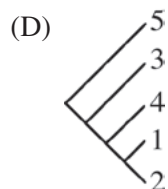
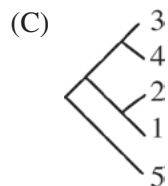
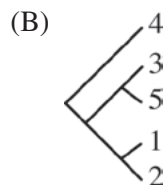
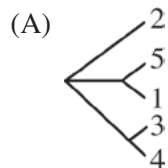

33. The mechanism of action of many common medications involves interfering with the normal pathways that cells use to respond to hormone signals. Which of the following best describes a drug interaction that directly interferes with a signal transduction pathway?

- (A) A medication causes the cell to absorb more of a particular mineral, eventually poisoning the cell.
- (B) A medication enters the target cell and inhibits an enzyme that normally synthesizes a second messenger.
- (C) A medication enters the target cell's nucleus and acts as a mutagen.
- (D) A medication interrupts the transcription of ribosomal RNA genes.

GO ON TO THE NEXT PAGE.

34. The first diagram below shows the levels of mRNA from two different genes (*bicoid* and *caudal*) at different positions along the anterior-posterior axis of a *Drosophila* egg immediately before fertilization. The second diagram shows the levels of the two corresponding proteins along the anterior-posterior axis shortly after fertilization.

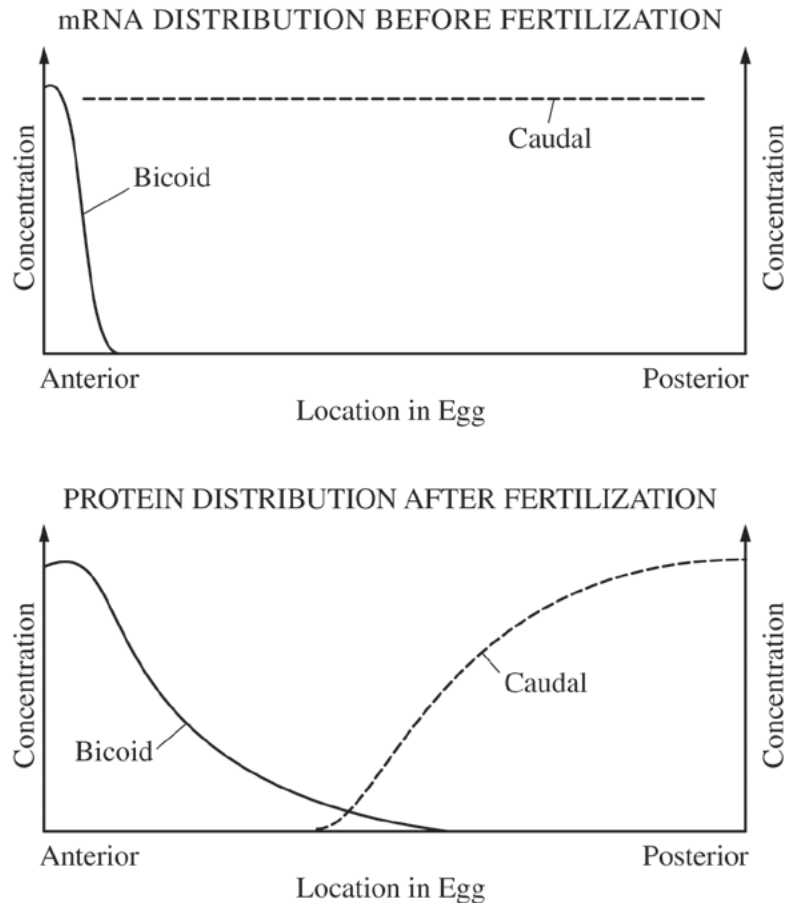

Which of the following conclusions is best supported by the data?

- (A) Bicoid protein inhibits translation of *caudal* mRNA.
- (B) Bicoid protein stabilizes *caudal* mRNA.
- (C) Translation of *bicoid* mRNA produces caudal protein.
- (D) Caudal protein stimulates development of anterior structures.

GO ON TO THE NEXT PAGE.

35. Living cells typically have biosynthetic pathways to synthesize at least some of the amino acids used in making proteins. Some strains of *E. coli*, a prokaryote, can synthesize the amino acid tryptophan, while other *E. coli* strains cannot. Similarly, some strains of the yeast *S. cerevisiae*, a eukaryote, can synthesize tryptophan, while other *S. cerevisiae* strains cannot.

Which of the following describes the most likely source of genetic variation found in the tryptophan synthesis pathways of both species?

- (A) Exchange of genetic information occurs through crossing over.
- (B) Viral transmission of genetic information required to synthesize tryptophan occurs.
- (C) Random assortment of chromosomes leads to genetic variation.
- (D) Errors in DNA replication lead to genetic variation.

36. Sickle-cell anemia results from a point mutation in the *HBB* gene. The mutation results in the replacement of an amino acid that has a hydrophilic R-group with an amino acid that has a hydrophobic R-group on the exterior of the hemoglobin protein. Such a mutation would most likely result in altered

- (A) properties of the molecule as a result of abnormal interactions between adjacent hemoglobin molecules
- (B) DNA structure as a result of abnormal hydrogen bonding between nitrogenous bases
- (C) fatty acid structure as a result of changes in ionic interactions between adjacent fatty acid chains
- (D) protein secondary structure as a result of abnormal hydrophobic interactions between R-groups in the backbone of the protein

GO ON TO THE NEXT PAGE.

37. In a hypothetical population of beetles, there is a wide variety of color, matching the range of coloration of the tree trunks on which the beetles hide from predators. The graphs below illustrate four possible changes to the beetle population as a result of a change in the environment due to pollution that darkened the tree trunks.

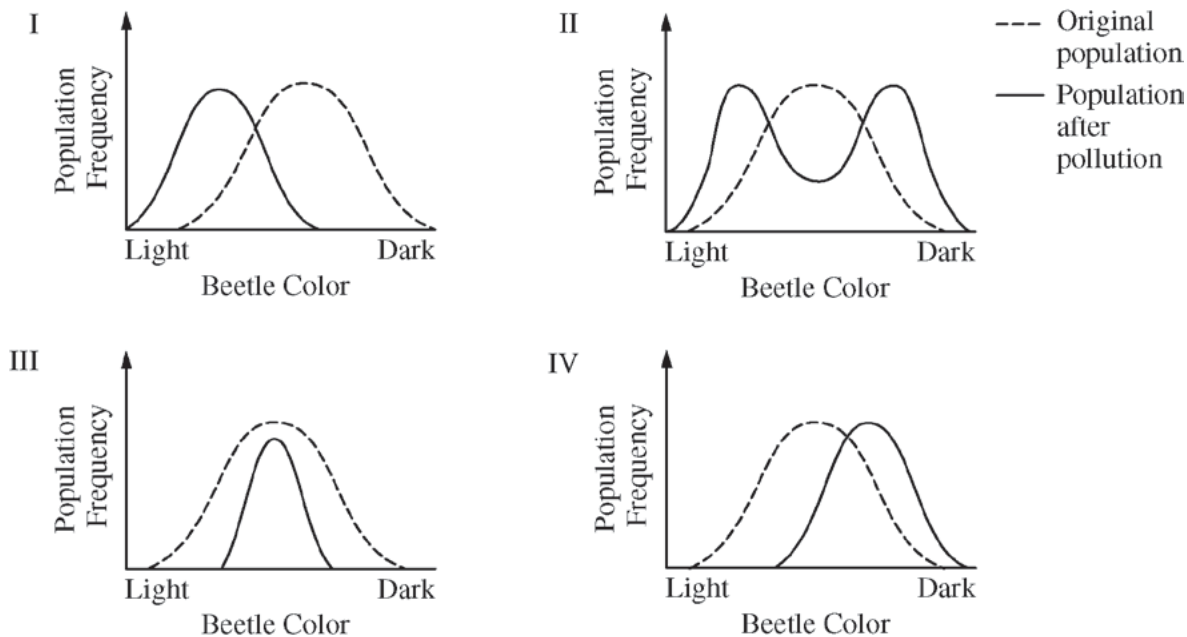

Which of the following includes the most likely change in the coloration of the beetle population after pollution and a correct rationale for the change?

- (A) The coloration range shifted toward more light-colored beetles, as in diagram I. The pollution helped the predators find the darkened tree trunks.
- (B) The coloration in the population split into two extremes, as in diagram II. Both the lighter-colored and the darker-colored beetles were able to hide on the darker tree trunks.
- (C) The coloration range became narrower, as in diagram III. The predators selected beetles at the color extremes.
- (D) The coloration in the population shifted toward more darker-colored beetles, as in diagram IV. The lighter-colored beetles were found more easily by the predators than were the darker-colored beetles.

GO ON TO THE NEXT PAGE.

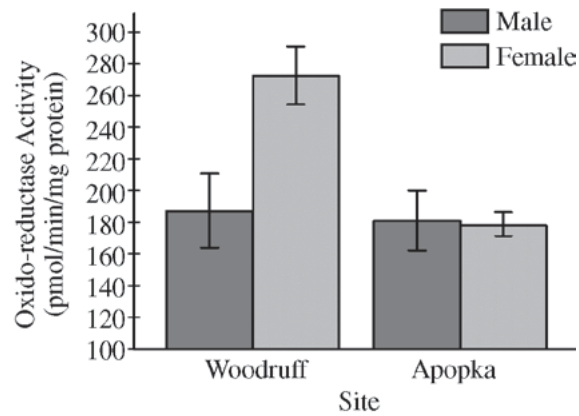

38. Testosterone oxido-reductase is a liver enzyme that regulates testosterone levels in alligators. One study compared testosterone oxido-reductase activity between male and female alligators from Lake Woodruff, a relatively pristine environment, and from Lake Apopka, an area that has suffered severe contamination. The graph above depicts the findings of that study.

The data in the graph best support which of the following claims?

- (A) Environmental contamination elevates total testosterone oxido-reductase activity in females.
- (B) Environmental contamination reduces total testosterone oxido-reductase activity in females.
- (C) Environmental contamination elevates total testosterone oxido-reductase activity in males.
- (D) Environmental contamination reduces total testosterone oxido-reductase activity in males.

GO ON TO THE NEXT PAGE.

39. An individual's humoral response to a particular antigen differs depending on whether or not the individual has been previously exposed to that antigen. Which of the following graphs properly represents the humoral immune response when an individual is exposed to the same antigen more than once?

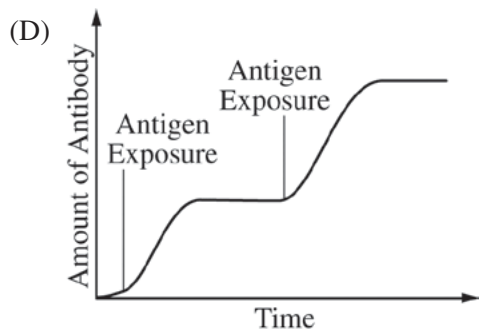
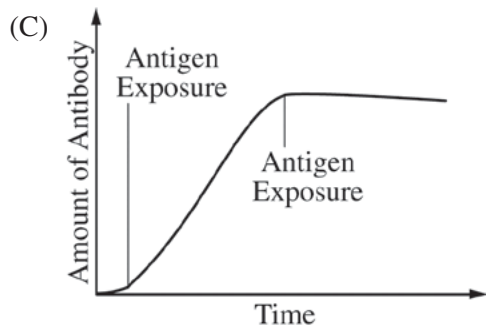
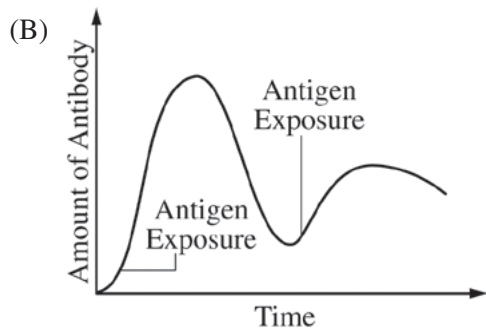
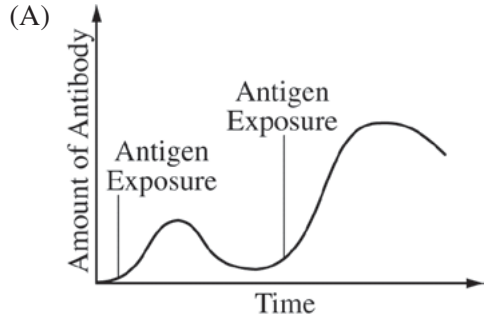

GO ON TO THE NEXT PAGE.

Questions 40-44

In a transformation experiment, a sample of *E. coli* bacteria was mixed with a plasmid containing the gene for resistance to the antibiotic ampicillin (*amp^r*). Plasmid was not added to a second sample. Samples were plated on nutrient agar plates, some of which were supplemented with the antibiotic ampicillin. The results of *E. coli* growth are summarized below. The shaded area represents extensive growth of bacteria; dots represent individual colonies of bacteria.

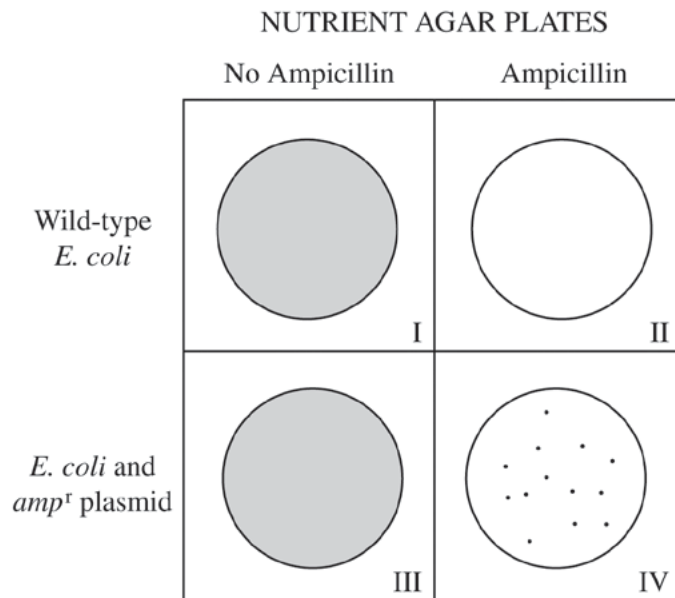

40. Plates that have only ampicillin-resistant bacteria growing include which of the following?
- (A) I only
(B) III only
(C) IV only
(D) I and II
41. Which of the following best explains why there is no growth on plate II?
- (A) The initial *E. coli* culture was not ampicillin-resistant.
(B) The transformation procedure killed the bacteria.
(C) Nutrient agar inhibits *E. coli* growth.
(D) The bacteria on the plate were transformed.
42. Plates I and III were included in the experimental design in order to
- (A) demonstrate that the *E. coli* cultures were viable
(B) demonstrate that the plasmid can lose its *amp^r* gene
(C) demonstrate that the plasmid is needed for *E. coli* growth
(D) prepare the *E. coli* for transformation
43. Which of the following statements best explains why there are fewer colonies on plate IV than on plate III?
- (A) Plate IV is the positive control.
(B) Not all *E. coli* cells are successfully transformed.
(C) The bacteria on plate III did not mutate.
(D) The plasmid inhibits *E. coli* growth.
44. In a second experiment, the plasmid contained the gene for human insulin as well as the *amp^r* gene. Which of the following plates would have the highest percentage of bacteria that are expected to produce insulin?
- (A) I only
(B) III only
(C) IV only
(D) I and III

GO ON TO THE NEXT PAGE.

45. Experimental evidence shows that the process of glycolysis is present and virtually identical in organisms from all three domains, Archaea, Bacteria, and Eukarya. Which of the following hypotheses could be best supported by this evidence?

- (A) All organisms carry out glycolysis in mitochondria.
- (B) Glycolysis is a universal energy-releasing process and therefore suggests a common ancestor for all forms of life.
- (C) Across the three domains, all organisms depend solely on the process of anaerobic respiration for ATP production.
- (D) The presence of glycolysis as an energy-releasing process in all organisms suggests that convergent evolution occurred.

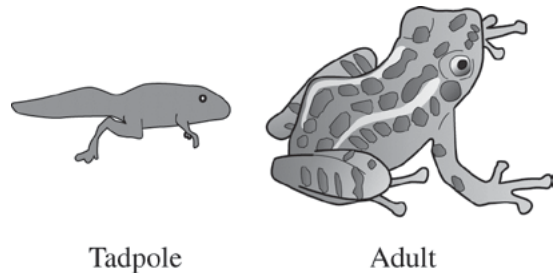

46. The last part of the metamorphosis of a tadpole to an adult frog results in the disappearance of the tail. This stage of development most likely occurs by
- (A) cells of the tail dying and the nutrients being absorbed and reused by the body
 - (B) shedding of the tail so energy is not spent on maintenance of an unneeded part
 - (C) bilateral division of the tail and fusion with the developing hind limbs
 - (D) individual cells of the tail migrating to the developing gonads

GO ON TO THE NEXT PAGE.

47. MRSA is the acronym for methicillin-resistant *Staphylococcus aureus*. Many of the strains of the common bacterium are also resistant to other antibiotics in use today. The resistance is linked to a collection of genes carried on plasmids that are passed from one bacterium to another by conjugation. Suppose a newly discovered, chemically different antibiotic is used in place of methicillin. Which of the following would be the most likely effect on *Staphylococcus aureus* antibiotic resistance?

- (A) The gene for methicillin resistance, no longer needed, would disappear entirely from *Staphylococcus aureus* populations within a few generations.
- (B) Transmission of the methicillin-resistance plasmid by conjugation would increase among the *Staphylococcus aureus* population as the genes would confer resistance to the new antibiotic.
- (C) Transmission of the methicillin-resistance plasmid would gradually decrease but the plasmid would not entirely disappear from the *Staphylococcus aureus* population.
- (D) Transmission of the methicillin-resistance plasmid by conjugation would increase among the *Staphylococcus aureus* population due to destruction of bacteria without the plasmid through use of the new antibiotic.

48. A human kidney filters about 200 liters of blood each day. Approximately two liters of liquid and nutrient waste are excreted as urine. The remaining fluid and dissolved substances are reabsorbed and continue to circulate throughout the body. Antidiuretic hormone (ADH) is secreted in response to reduced plasma volume. ADH targets the collecting ducts in the kidney, stimulating the insertion of aquaporins into their plasma membranes and an increased reabsorption of water.

If ADH secretion is inhibited, which of the following would initially result?

- (A) The number of aquaporins would increase in response to the inhibition of ADH.
- (B) The person would decrease oral water intake to compensate for the inhibition of ADH.
- (C) Blood filtration would increase to compensate for the lack of aquaporins.
- (D) The person would produce greater amounts of dilute urine.

GO ON TO THE NEXT PAGE.

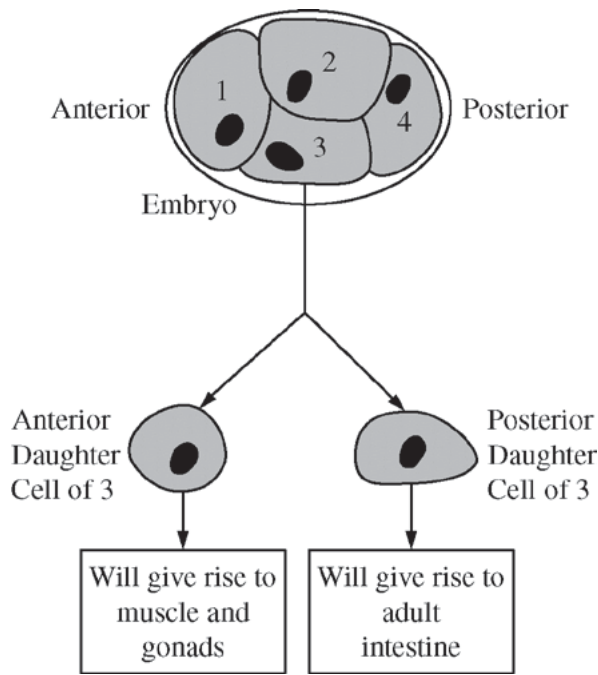

49. The diagram above shows a developing worm embryo at the four-cell stage. Experiments have shown that when cell 3 divides, the anterior daughter cell gives rise to muscle and gonads and the posterior daughter cell gives rise to the intestine. However, if the cells of the embryo are separated from one another early during the four-cell stage, no intestine will form. Other experiments have shown that if cell 3 and cell 4 are recombined after the initial separation, the posterior daughter cell of cell 3 will once again give rise to normal intestine. Which of the following is the most plausible explanation for these findings?
- (A) A cell surface protein on cell 4 signals cell 3 to induce formation of the worm's intestine.
 - (B) The plasma membrane of cell 4 interacts with the plasma membrane of the posterior portion of cell 3, causing invaginations that become microvilli.
 - (C) Cell 3 passes an electrical signal to cell 4, which induces differentiation in cell 4.
 - (D) Cell 4 transfers genetic material to cell 3, which directs the development of intestinal cells.

50. The tiny blue-eyed Mary flower is often one of the first flowers seen in the spring in some regions of the United States. The flower is normally blue, but sometimes a white or pink flower variation is found.

The following data were obtained after several crosses.

Parents	F ₁	F ₂
Blue × white	Blue	196 blue, 63 white
Blue × pink	Blue	149 blue, 52 pink
Pink × white	Blue	226 blue, 98 white, 77 pink

Which of the following statements best explains the data?

- (A) The appearance of blue in the F₁ generation of the pink and white cross demonstrates that flower color is not an inherited trait but is determined by the environment.
- (B) Flower color depends on stages of flower development, and young flowers are white, advancing to pink and then blue.
- (C) Since the F₁ and F₂ phenotypes of the pink and white cross do not fit the expected genotypic and phenotypic ratios, blue-eyed Mary must reproduce by vegetative propagation.
- (D) Flower color is an inherited trait, and the F₁ and F₂ phenotypes of the flowers arising from the pink and white cross can best be explained by another gene product that influences the phenotypic expression.

GO ON TO THE NEXT PAGE.

Questions 51-53

Both myoglobin and hemoglobin are proteins that bind reversibly with molecular oxygen. The graph below shows the oxygen-binding saturation of each protein at different concentrations of oxygen.

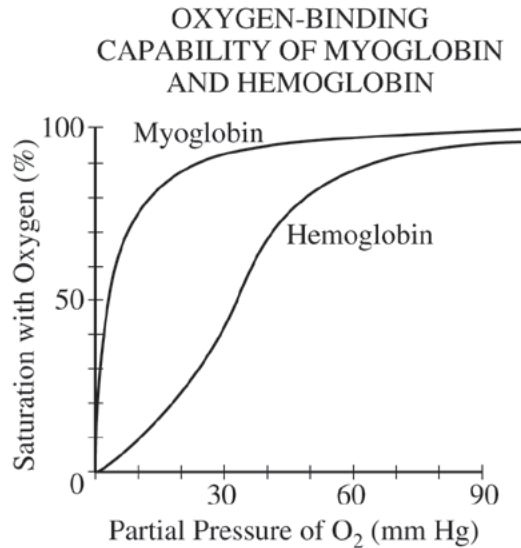

51. Which of the following statements is correct?
- (A) At 10 mm Hg partial pressure, hemoglobin binds oxygen but myoglobin does not.
 - (B) At 20 mm Hg partial pressure, myoglobin and hemoglobin bind oxygen in equal amounts.
 - (C) At 40 mm Hg partial pressure, myoglobin has a greater affinity for oxygen than hemoglobin has.
 - (D) At 80 mm Hg partial pressure, myoglobin binds twice as much oxygen as hemoglobin binds.

52. Strenuous exercise lowers the blood pH, causing the curves for both hemoglobin and myoglobin to shift to the right. This shift results in
- (A) an unloading of O₂ at higher partial pressures
 - (B) an increase in the number of O₂-binding sites
 - (C) the capture of more O₂ by hemoglobin
 - (D) the capture of more O₂ by myoglobin
53. Which of the following best describes the physiological significance of the different oxygen-binding capabilities of hemoglobin and myoglobin?
- (A) They prevent muscles from depleting oxygen levels in the blood.
 - (B) They cause muscles to become anaerobic.
 - (C) They prevent glycogen depletion in muscles.
 - (D) They enhance movement of oxygen from the blood into the muscles.

GO ON TO THE NEXT PAGE.

Ara Operon

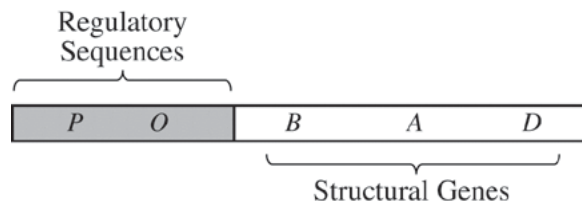

54. The regulatory sequences of the operon controlling arabinose metabolism (*ara* operon) were studied to determine whether bacteria can respond to changes in nutrient availability. It is predicted that if those regulatory sequences are functioning properly, the bacteria will produce the enzymes involved in arabinose metabolism (structural genes *B*, *A*, and *D*) in the presence of arabinose.

If a gene that encodes a green fluorescent protein (GFP) is substituted for the structural genes of the operon, activation of the regulatory sequences can be assayed by GFP expression. A culture of *E. coli* cells underwent a transformation procedure with a plasmid containing the regulatory sequences of the *ara* operon directly upstream of the gene encoding the GFP. The plasmid also confers ampicillin resistance to bacteria. Samples were then plated on different types of culture media. (Note: The GFP fluoresces only under UV light, not under white light.) The table below shows the results.

Transformation Results

Type of Culture Media			Color of Colonies Under White Light	Color of Colonies Under UV Light
Agar	Ampicillin	Arabinose		
+	–	–	All white	All white
+	+	–	All white	All white
+	–	+	All white	Mostly white, some green
+	+	+	All white	All green

+ Indicates the presence of the indicated substance in the culture media

– Indicates the absence of the indicated substance in the culture media

Which of the following can best be used to justify why the GFP is expressed by *E. coli* cells after transformation with the plasmid?

- (A) The presence of arabinose in the nutrient agar activated the expression of the genes located downstream of the *ara* operon regulatory sequences.
- (B) The combination of ampicillin and arabinose in the nutrient agar inhibited the expression of certain gene products, resulting in the increased expression of the GFP.
- (C) The nutrient agar without arabinose but with ampicillin activated the expression of the genes located downstream of the *ara* operon regulatory sequences.
- (D) Both arabinose and ampicillin were required in the nutrient agar to activate the expression of genes located downstream of the *ara* operon regulatory sequences.

GO ON TO THE NEXT PAGE.

55. The chemical reaction for photosynthesis is



If the input water is labeled with a radioactive isotope of oxygen, ^{18}O , then the oxygen gas released as the reaction proceeds is also labeled with ^{18}O . Which of the following is the most likely explanation?

- (A) During the light reactions of photosynthesis, water is split, the hydrogen atoms combine with the CO_2 , and oxygen gas is released.
- (B) During the light reactions of photosynthesis, water is split, removing electrons and protons, and oxygen gas is released.
- (C) During the Calvin cycle, water is split, regenerating NADPH from NADP^+ , and oxygen gas is released.
- (D) During the Calvin cycle, water is split, the hydrogen atoms are added to intermediates of sugar synthesis, and oxygen gas is released.

GO ON TO THE NEXT PAGE.

56. A culture of *Spirogyra* (an autotrophic alga) is maintained in a water solution containing dissolved carbon dioxide and a source of phosphates but lacking nitrogen compounds. A researcher determines the rates of synthesis of several organic compounds found in the *Spirogyra* before and after several weeks in the water solution. Which of the following graphs best illustrates a likely result of the experiment?

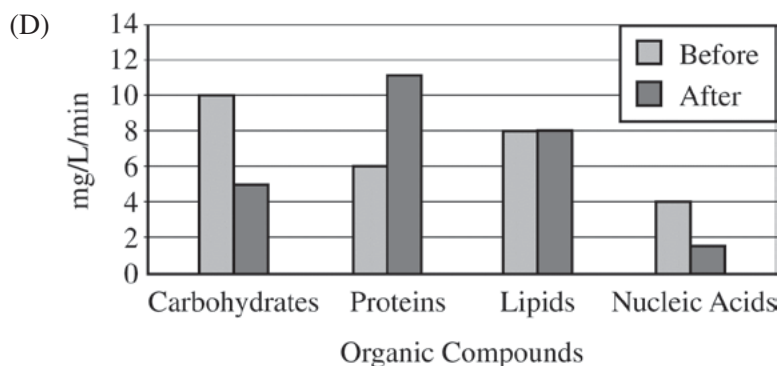
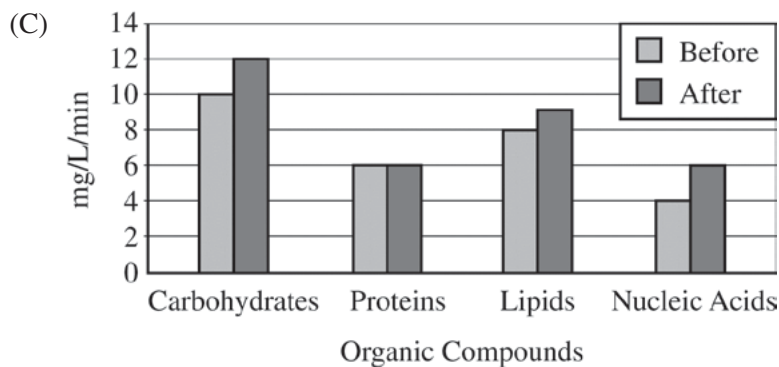
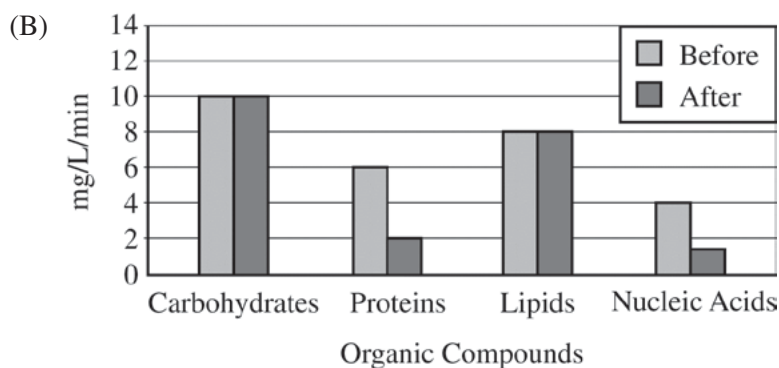
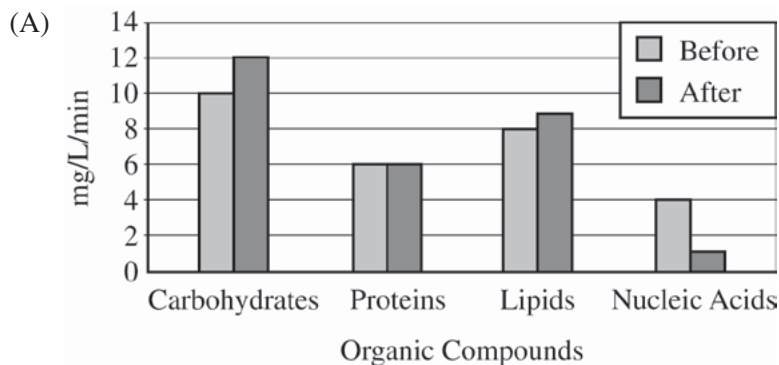

GO ON TO THE NEXT PAGE.

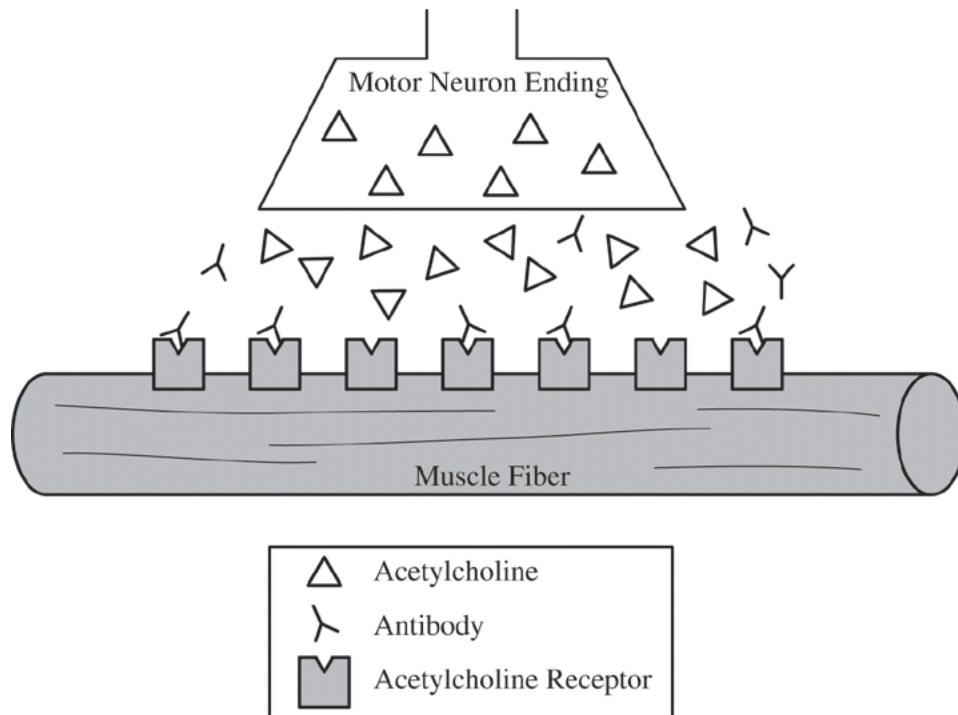

57. The illustration above depicts a neuromuscular junction of a patient with an autoimmune disorder. Acetylcholine is a stimulatory neurotransmitter. Which of the following would be the most likely result of the continued presence of the antibody?
- (A) An increase in action potentials in the motor neuron and constant nerve pain
 - (B) A decrease in action potentials in the muscle, causing muscle weakness and fatigue
 - (C) A decrease in the opening of sodium-gated channels in the muscle, causing less sodium to be released from the muscle
 - (D) An increase in the opening of sodium-gated channels in the motor neuron because of the accumulation of acetylcholine in the junction

GO ON TO THE NEXT PAGE.

58. A group of students summarized information on five great extinction events.

Mass Extinction	Time of Extinction	Organisms Greatly Reduced or Made Extinct
End of the Ordovician period	443 million years ago	Trilobites, brachiopods, echinoderms, and corals
End of the Devonian period	354 million years ago	Marine families on tropical reefs, corals, brachiopods, and bivalves
End of the Permian period	248 million years ago	Trilobites, mollusks, brachiopods, and many vertebrates
End of the Triassic period	206 million years ago	Mollusks, sponges, marine vertebrates, and large amphibians
End of the Cretaceous period	65 million years ago	Ammonites, dinosaurs, brachiopods, bivalves, and echinoderms

The students are sampling a site in search of fossils from the Devonian period. Based on the chart, which of the following would be the most reasonable plan for the students to follow?

- (A) Searching horizontal rock layers in any class of rock and try to find those that contain the greatest number of fossils
- (B) Collecting fossils from rock layers deposited prior to the Permian period that contain some early vertebrate bones
- (C) Looking in sedimentary layers next to bodies of water in order to find marine fossils of bivalves and trilobites
- (D) Using relative dating techniques to determine the geological ages of the fossils found so they can calculate the rate of speciation of early organisms

GO ON TO THE NEXT PAGE.

59. *Anabaena* is a simple multicellular photosynthetic cyanobacterium. In the absence of fixed nitrogen, certain newly developing cells along a filament express genes that code for nitrogen-fixing enzymes and become non-photosynthetic heterocysts. The specialization is advantageous because some nitrogen-fixing enzymes function best in the absence of oxygen. Heterocysts do not carry out photosynthesis but instead provide adjacent cells with fixed nitrogen, in exchange receiving fixed carbon and reduced energy carriers.

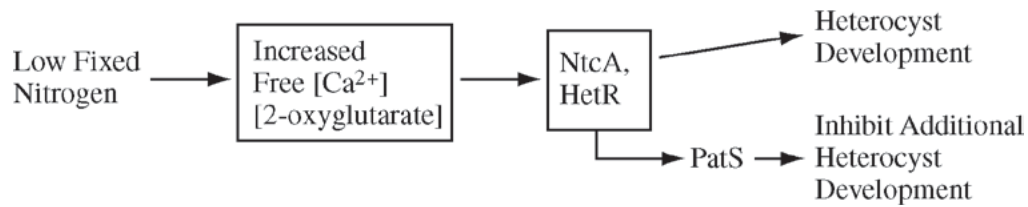

As shown in the diagram above, when there is low fixed nitrogen in the environment, an increase in the concentration of free calcium ions and 2-oxyglutarate stimulates the expression of genes that produce two transcription factors (NtcA and HetR) that promote the expression of genes responsible for heterocyst development. HetR also causes production of a signal, PatS, that prevents adjacent cells from developing as heterocysts.

Based on your understanding of the ways in which signal transmission mediates cell function, which of the following predictions is most consistent with the information given above?

- (A) In an environment with low fixed nitrogen, treating the *Anabaena* cells with a calcium-binding compound should prevent heterocyst differentiation.
- (B) A strain that overexpresses the *patS* gene should develop many more heterocysts in a low fixed nitrogen environment.
- (C) In an environment with abundant fixed nitrogen, free calcium levels should be high in all cells so that no heterocysts develop.
- (D) In environments with abundant fixed nitrogen, loss of the *hetR* gene should induce heterocyst development.

GO ON TO THE NEXT PAGE.

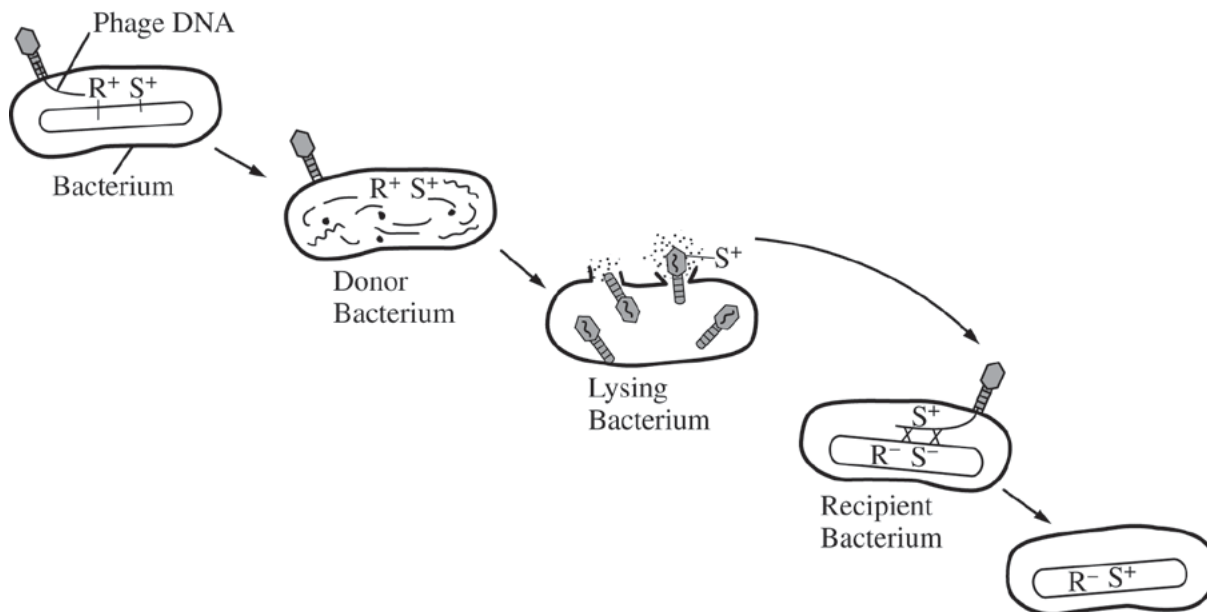

60. The figure above shows several steps in the process of bacteriophage transduction in bacteria. Which of the following explains how genetic variation in a population of bacteria results from this process?
- Bacterial proteins transferred from the donor bacterium by the phage to the recipient bacterium recombine with genes on the recipient's chromosome.
 - The recipient bacterium incorporates the transduced genetic material coding for phage proteins into its chromosome and synthesizes the corresponding proteins.
 - The phage infection of the recipient bacterium and the introduction of DNA carried by the phage cause increased random point mutations of the bacterial chromosome.
 - DNA of the recipient bacterial chromosome undergoes recombination with DNA introduced by the phage from the donor bacterium, leading to a change in the recipient's genotype.

GO ON TO THE NEXT PAGE.

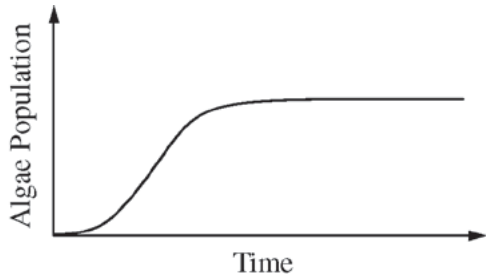

Figure I

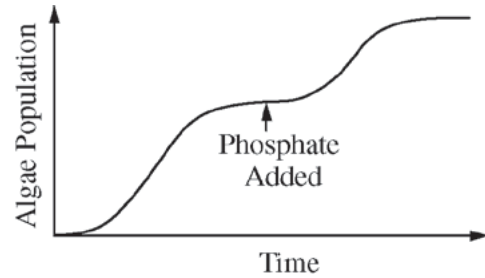
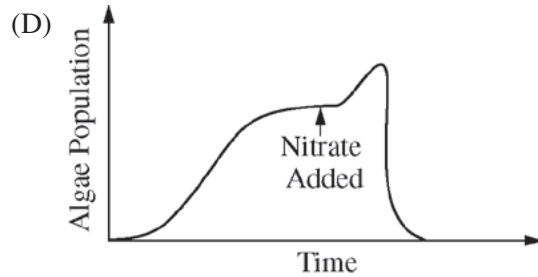
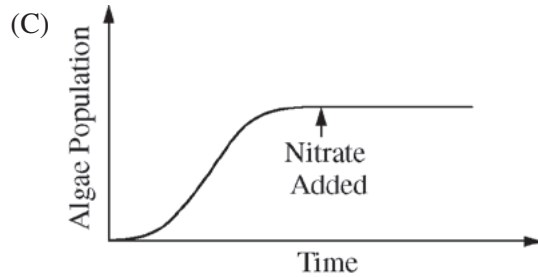
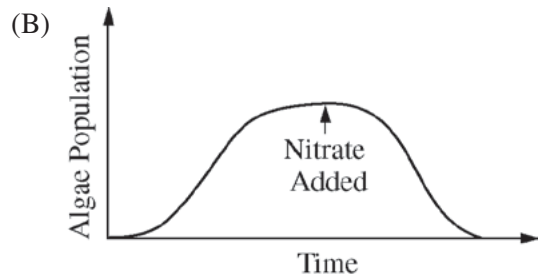
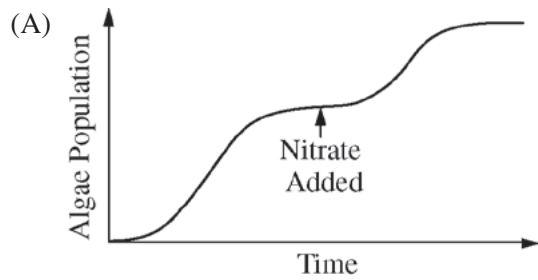

Figure II

61. Figure I shows the growth of an algal species in a flask of sterilized pond water. If phosphate is added as indicated, the growth curve changes as shown in Figure II.

Which of the following is the best prediction of the algal growth if nitrate is added instead of phosphate?



GO ON TO THE NEXT PAGE.

62. The figures below illustrate the similarities between ATP synthesis in mitochondria and chloroplasts.

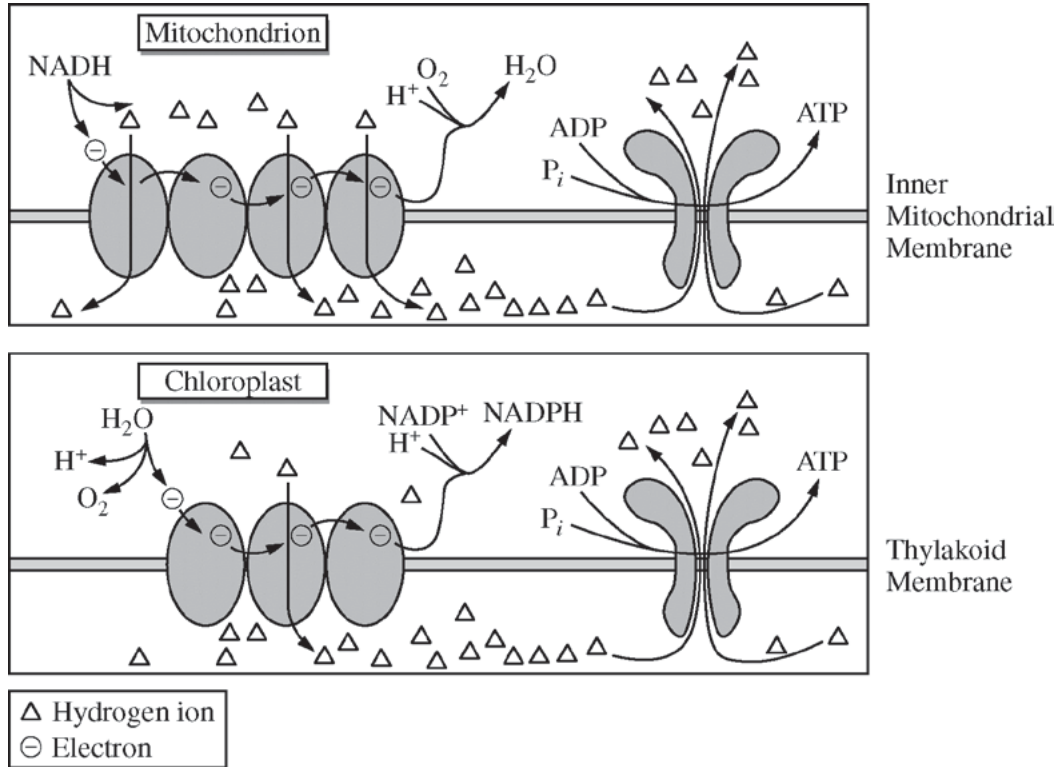

The figures can best assist in answering which of the following questions?

- (A) Do electron transport chains create a gradient so that ATP synthase can generate ATP molecules?
- (B) What are the sources of energy that drive mitochondrial and chloroplast electron transport systems?
- (C) What is the optimal temperature at which ATP synthase chemically converts ADP and a phosphate group into one molecule of ATP?
- (D) What is the evolutionary relationship between the ATP synthase in mitochondria and the ATP synthase in chloroplasts?

GO ON TO THE NEXT PAGE.

63. The Hedgehog protein (Hh) plays a critical role during a certain period of embryo development, but it normally has no role in adults except for the maintenance of adult stem cells. However, the Hedgehog protein has been detected in 70 percent of pancreatic cancer cell samples. As illustrated in the figures below, the Hedgehog protein binds to an integral membrane protein receptor known as Patched (Ptc), thus initiating a pathway of gene expression. When Hedgehog is absent, Ptc inhibits another protein known as Smoothed (Smo), which, in turn, blocks the activation of a group of proteins collectively known as the Hedgehog signaling complex (HSC). The inactivation is the result of proteolytic cleavage of one component of the HSC complex, a transcription factor known as Cubitus interruptus (Ci). When Hedgehog is present, it binds to Ptc, which prevents the inhibition of Smo by Ptc. The result is that Ci remains intact and can enter the nucleus, where it binds to and activates certain genes.

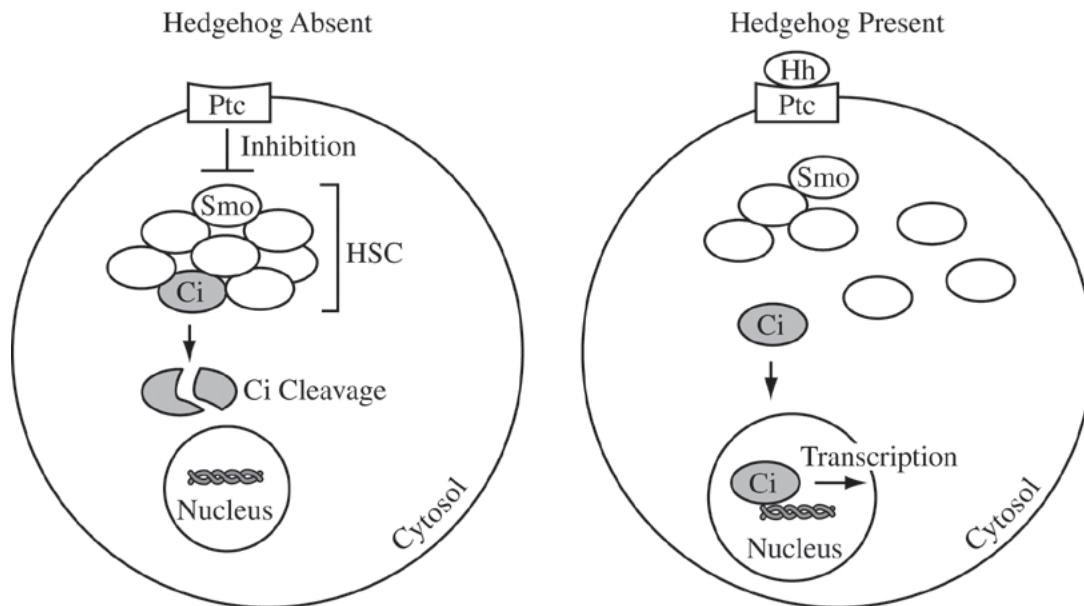

One approach to treating patients with pancreatic cancer and other cancers in which the Hedgehog protein is detected is to modify the Hedgehog signaling pathway. Which of the following is the most useful approach?

- (A) Treating patients with a molecule that is structurally similar to Hedgehog and that will bind to and interact with Ptc in the same fashion as Hedgehog
- (B) Injecting patients with embryonic cells so that Hedgehog will bind to those cells instead of the cancer cells
- (C) Treating patients with a membrane-soluble compound that can bind to Smo and block its activity
- (D) Injecting patients with a preparation of purified membrane-soluble Ci that will enter the nuclei of the cancer cells and induce gene transcription

END OF PART A

DO NOT STOP

PLEASE CONTINUE TO PART B

GO ON TO THE NEXT PAGE.

Part B Directions: Part B consists of six questions requiring numeric answers. Calculate the correct answer for each question, and enter on the line provided on the answer sheet.

GO ON TO THE NEXT PAGE.

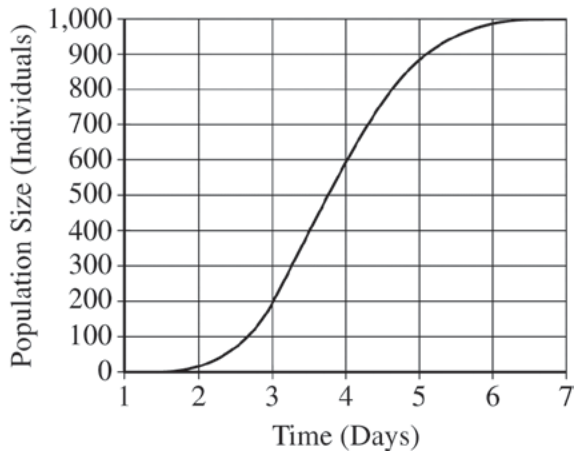

- Use the graph above to calculate the mean rate of population growth (individuals per day) between day 3 and day 5. Give your answer to the nearest whole number.

- In a certain species of flowering plant, the purple allele P is dominant to the yellow allele p .

A student performed a cross between a purple-flowered plant and a yellow-flowered plant. When planted, the 146 seeds that were produced from the cross matured into 87 plants with purple flowers and 59 plants with yellow flowers.

Calculate the chi-squared value for the null hypothesis that the purple-flowered parent was heterozygous for the flower-color gene. Give your answer to the nearest tenth.

GO ON TO THE NEXT PAGE.

ENERGY FLOW IN A HARDWOOD FOREST (kJ/m²)

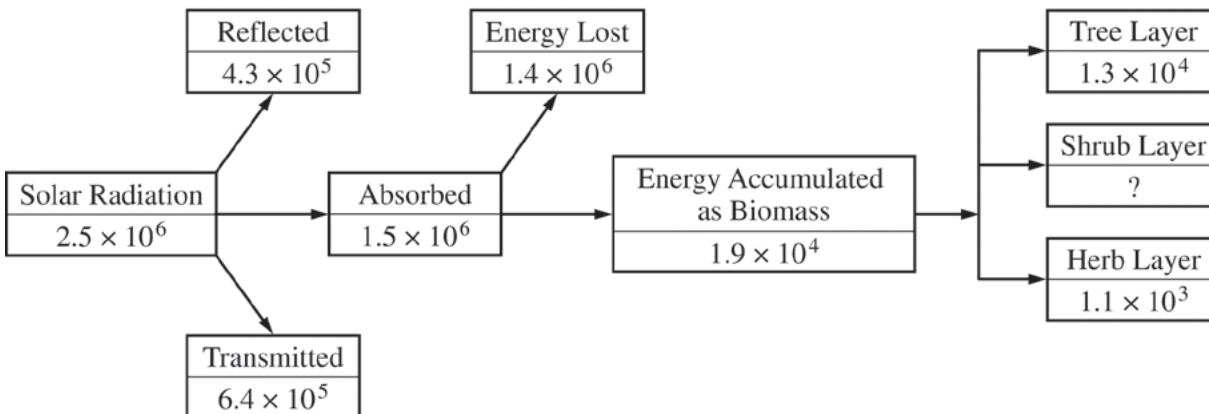

3. What percent of the biomass in the forest community represented above is tied up in the shrub layer? Give your answer to the nearest whole number.

4. In a population of certain frogs in which the allele for brown skin is dominant to the allele for green skin, a drought leads to selection against green-skinned frogs. When the drought ends, 12 percent of the remaining frogs exhibit the green-skin phenotype. If the population is now in Hardy-Weinberg equilibrium, what will be the frequency of the green-skin allele in the next generation? Provide your answer to the nearest hundredth.

GO ON TO THE NEXT PAGE.

COMPARISON OF PREY AND PREDATOR POPULATIONS

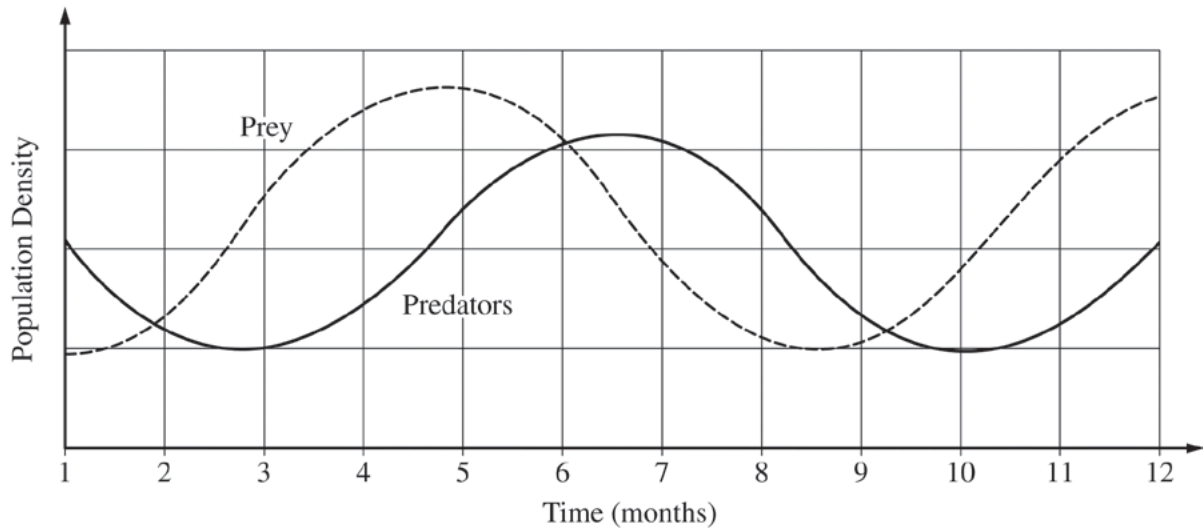

5. Use the graph above to calculate the lag time in months between the change in the densities of the prey and the predator populations. Give your answer to the nearest tenth of a month.

GO ON TO THE NEXT PAGE.

CARBON FLOW IN A GRASSLAND ECOSYSTEM

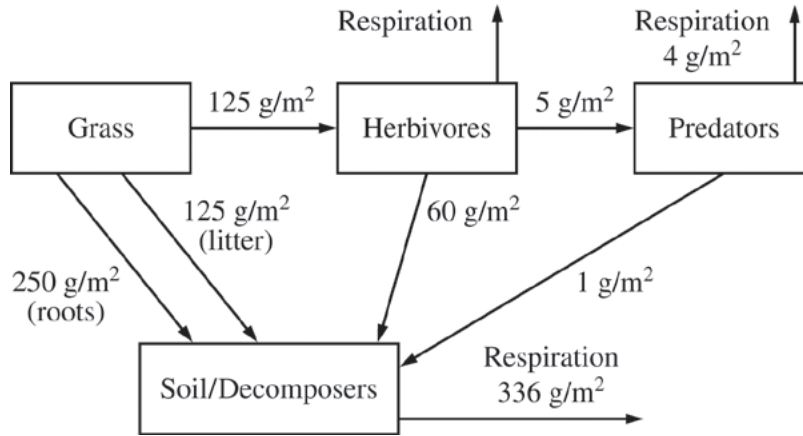

6. How much carbon (in g/m^2) is released into the atmosphere as a result of the metabolic activity of herbivores? Give your answer to the nearest whole number.

END OF SECTION I

**IF YOU FINISH BEFORE TIME IS CALLED, YOU MAY
CHECK YOUR WORK.**

DO NOT GO ON TO SECTION II UNTIL YOU ARE TOLD TO DO SO.

AP[®] Biology Practice Exam

SECTION II: Free Response

DO NOT OPEN THIS BOOKLET UNTIL YOU ARE TOLD TO DO SO.

At a Glance

Total Time

1 hour, 30 minutes

Number of Questions

8

Percent of Total Score

50%

Writing Instrument

Pen with black or dark blue ink

Electronic Device

Four-function calculator allowed

Reading Period

Time

10 minutes. Use this time to read the questions and plan your answers.

Writing Period

Time

1 hour, 20 minutes

Suggested Time

Approximately 20 minutes or 6 minutes, as indicated in the directions.

IMPORTANT Identification Information

PLEASE PRINT WITH PEN:

1. First two letters of your last name
First letter of your first name
2. Date of birth

Month Day Year
3. Six-digit school code
4. Unless I check the box below, I grant the College Board the unlimited right to use, reproduce, and publish my free-response materials, both written and oral, for educational research and instructional purposes. My name and the name of my school will not be used in any way in connection with my free-response materials. I understand that I am free to mark "No" with no effect on my score or its reporting.

No, I do not grant the College Board these rights.

Instructions

The questions for Section II are printed in this booklet. You may use the following page of this booklet to organize your answers and for scratch work, but you must write your answers on the lined pages provided for each question.

The proctor will announce the beginning and end of the reading period. You are advised to spend the 10-minute period reading all the questions, and to use the following page to sketch graphs, make notes, and plan your answers. Do NOT begin writing on the lined pages until the proctor tells you to do so.

Note that each question has an associated suggested time. The number of pages available for each response should also be considered a guide as to how long each response should be. Each answer should be in organized, well-balanced, and comprehensive prose form; outline form is not acceptable. Do not spend time restating the questions or providing more than the number of examples called for. For instance, if a question calls for two examples, you can earn credit only for the first two examples you provide. Diagrams may be used to supplement discussion, but diagrams alone will not suffice, unless required by the question. Write clearly and legibly. Begin each answer following the appropriate question. Do not skip lines. Cross out any errors you make; crossed-out work will not be scored.

Manage your time carefully. You may proceed freely from one question to the next. You may review your responses if you finish before the end of the exam is announced.



Minimum 20% post-consumer waste

NO TEST MATERIAL ON THIS PAGE

BIOLOGY
Section II
8 Free-Response Questions
Time—80 minutes

Directions: Questions 1 and 2 are long free-response questions that should require about 20 minutes each to answer. Questions 3 through 8 are short free-response questions that should require about 6 minutes each to answer. Read each question carefully and write your response in the space provided following each question. Only material written in this space will be scored. Answers must be written out. Outline form is not acceptable. It is important that you read each question completely before you begin to write.

1. In a certain prairie community, a dominant prairie grass species has recently been infected with a virus that disrupts one of the electron transport proteins in the chloroplasts of infected cells.
- (a) **Describe** the most likely effects on cellular processes (be specific as to which processes and molecules are most likely to be directly affected).
 - (b) **Describe** and **explain** the most likely effects on individual infected plants.
 - (c) **Predict** the short-term effects (within a year of infection) on the infected plant populations and their communities. **Justify** your prediction.
 - (d) **Predict** the long-term effects (years to decades after infection) on the infected plant populations and their communities. **Justify** your prediction.

GO ON TO THE NEXT PAGE.

2. Plants lose water from their aboveground surfaces in the process of transpiration. Most of this water is lost from stomata, microscopic openings in the leaves. Excess water loss can have a negative effect on the growth, development, and reproduction of a plant. Severe water loss can be fatal. Environmental factors have a major impact on the rate of plant transpiration.

TRANSPIRATION RATE VERSUS TEMPERATURE

Temperature (°C)	20	23	27	28
Transpiration rate (mmol/m ² •sec)	1.5	3	5	4.5

- (a) Using the data above and the axes provided, **draw** a graph showing the effect of temperature change on the rate of transpiration. **Explain** the shape of the curve from 23 degrees to 28 degrees.
- (b) Humidity is another environmental factor that affects transpiration rate. Using the axes provided, **draw** a curve that illustrates what you predict would be the rate of transpiration with increasing humidity and constant temperature. **Justify** the shape of the curve based on your prediction.
- (c) The curve below illustrates the rate of transpiration related to the percent of open stomata on the leaf of a particular plant. **Explain** why the curve levels off with increasing percentage of open stomata per area of the leaf.

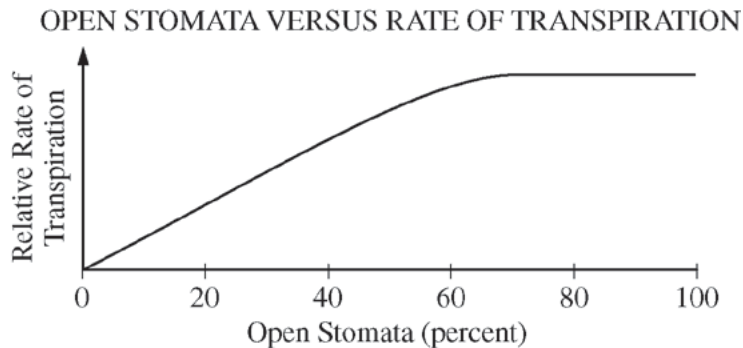

- (d) The data below show the density of stomata on the leaf surfaces of three different species of plants. **Describe** the environments in which each plant most likely evolved. **Justify** your descriptions.

Plant	Stomata Density (# of stomata/mm ²)	
	In Upper Epidermis	In Lower Epidermis
Anacharis	0	0
Water lily	420	0
Black walnut	0	465

GO ON TO THE NEXT PAGE.

Graph for part (a) showing the effect of temperature on the rate of transpiration.

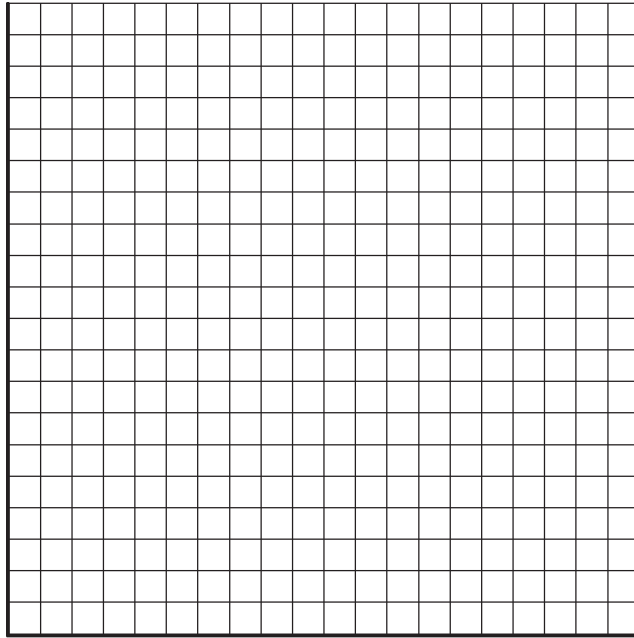

Graph for part (b) showing the predicted effect of humidity on the rate of transpiration.

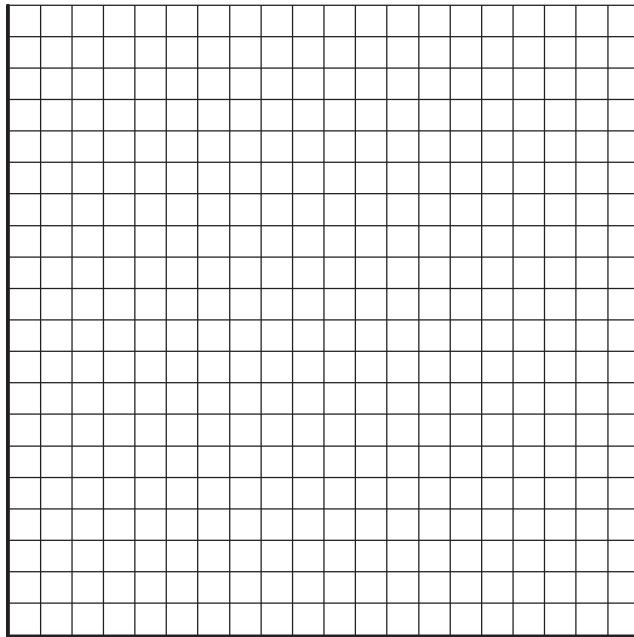

GO ON TO THE NEXT PAGE.

GO ON TO THE NEXT PAGE.

3. In fruit flies (*Drosophila melanogaster*), straight wing shape is dominant to curly wing shape. A particular population of fruit flies is in Hardy-Weinberg equilibrium with respect to the alleles for wing shape.

The Hardy-Weinberg equation, given below, is useful in understanding population genetics:

$$p^2 + 2pq + q^2 = 1$$

- (a) **Explain** what the terms (p^2 , $2pq$, and q^2) represent in the population of fruit flies.
- (b) **Describe** one condition that is necessary for the population to be in equilibrium.

GO ON TO THE NEXT PAGE.

4. Populations of a plant species have been found growing in the mountains at altitudes above 2,500 meters. Populations of a plant that appears similar, with slight differences, have been found in the same mountains at altitudes below 2,300 meters.
- (a) **Describe** TWO kinds of data that could be collected to provide a direct answer to the question, do the populations growing above 2,500 meters and the populations growing below 2,300 meters represent a single species?
- (b) **Explain** how the data you suggested in part (a) would provide a direct answer to the question.

GO ON TO THE NEXT PAGE.

5. In eukaryotic cells, ribosomes are found both free in the cytosol and attached to the endoplasmic reticulum (ER). Proteins produced on the attached ribosomes are delivered to the ER, while proteins produced on free ribosomes are delivered to the cytosol. **Briefly explain** in one or two sentences the two processes in terms of the following:

- ONE ultimate destination of a protein produced on an attached ribosome, and ONE general function of the protein (You do not need to identify the specific protein.)
- ONE ultimate destination of a protein produced on a free ribosome, and ONE general function of the protein (You do not need to identify the specific protein.)

GO ON TO THE NEXT PAGE.

6. Fruit flies (*Drosophila melanogaster*) with a wild-type phenotype have gray bodies and red eyes. Certain mutations can cause changes to these traits. Mutant flies may have a black body and/or cinnabar eyes. To study the genetics of these traits, a researcher crossed a true-breeding wild-type male fly (with gray body and red eyes) with a true-breeding female fly with a black body and cinnabar eyes. All of the F₁ progeny displayed a wild-type phenotype.

Female flies from the F₁ generation were crossed with true-breeding male flies with black bodies and cinnabar eyes. The table below represents the predicted outcome and the data obtained from the cross. **Explain** the difference between the expected data and the actual numbers observed.

F ₂ Generation Phenotypes			
Body Color	Eye Color	Number Predicted	Number Observed
Gray	Red	244	455
Black	Cinnabar	244	432
Gray	Cinnabar	244	42
Black	Red	244	47

GO ON TO THE NEXT PAGE.

7. A population of microscopic eukaryotic organisms growing in a large flask had the growth pattern shown.

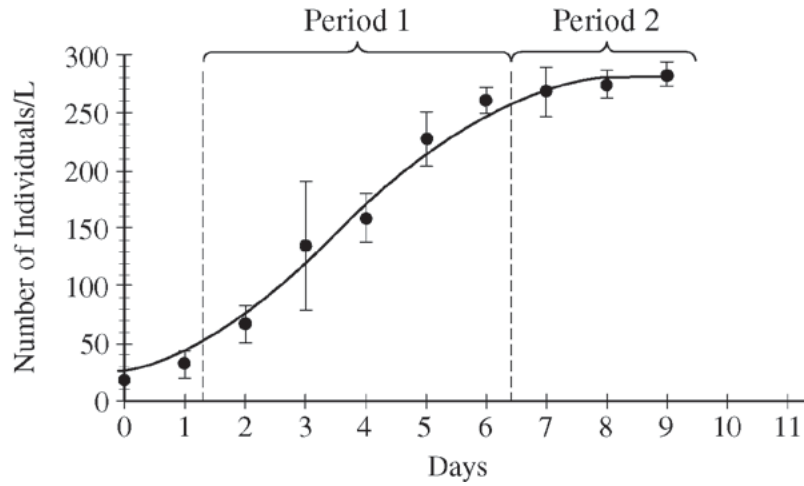

In one paragraph, **explain** the biological factors that determine the shape of the growth pattern shown above in both period 1 and period 2.

GO ON TO THE NEXT PAGE.

8. Fossils of a microscopic organism are found in rocks determined to be over 3.5 billion years old. **Identify** TWO types of evidence that would help answer the question of whether the organism was photosynthetic.

GO ON TO THE NEXT PAGE.

STOP
END OF EXAM



Notes on the Practice Exam

Introduction

This section provides a description of how the questions in the AP Practice Exam correspond to the components of the curriculum framework included in the *AP Biology Course and Exam Description*. For each of the questions in the AP Practice Exam, the targeted learning objectives, essential knowledge, and science practices from the curriculum framework are indicated.

In addition, the multiple-choice and free-response questions include the following features:

- For multiple-choice questions, the correct response is indicated with a justification for why it is correct. There are additional explanations that address why the other responses are incorrect.
- Free-response questions include scoring guidelines as well as descriptions of student responses that would represent “strong, good, and weak” levels. These scoring guidelines demonstrate how the essential knowledge and application of the science practices are assessed in each free-response question.

The 2013 AP Biology Exam is approximately 3 hours in length. There are two sections, each accounting for 50 percent of the student’s AP Exam score.

- Section I is 90 minutes long and consists of 63 multiple-choice questions and 6 grid-in questions.
- Section II is 90 minutes long and consists of 2 long free-response questions and 6 short free-response questions. It begins with a 10-minute reading period for students to read the questions and plan their answers. The remaining 80 minutes is for responding to the questions.

Section	Question Type	Number of Questions	Timing
I	Multiple Choice	63	90 minutes
	Grid-In	6	
II	Long Free Response	2	80 minutes + 10-minute Reading Period
	Short Free Response	6	

All of the questions on the exam are designed to measure the student’s understanding of the big ideas, enduring understandings, and essential knowledge, and the student’s application of this understanding through the science practices.

Multiple-Choice Section

In Section I there are 63 multiple-choice questions. These questions represent the knowledge and skills students should know, understand, and be able to apply. Section I also includes 6 grid-in questions that require the integration of science and mathematical skills. For the grid-in responses, students will need to calculate the answer for each question and enter it in the grid on the answer sheet provided. Note: For this practice exam and publication, the grids included on the answer sheet have been modified. The sample grids below are more representative of what students will actually see on the AP Biology Exam answer sheet.

Integer answer 502				
	5	0	2	
⊖	.	/	/	.
(1)	(1)	(1)	(1)	(1)
(2)	(2)	(2)	(2)	(2)
(3)	(3)	(3)	(3)	(3)
(4)	(4)	(4)	(4)	(4)
(5)	(5)	(5)	(5)	(5)
(6)	(6)	(6)	(6)	(6)
(7)	(7)	(7)	(7)	(7)
(8)	(8)	(8)	(8)	(8)
(9)	(9)	(9)	(9)	(9)

Integer answer 502				
	5	0	2	
⊖	.	/	/	.
(1)	(1)	(1)	(1)	(1)
(2)	(2)	(2)	(2)	(2)
(3)	(3)	(3)	(3)	(3)
(4)	(4)	(4)	(4)	(4)
(5)	(5)	(5)	(5)	(5)
(6)	(6)	(6)	(6)	(6)
(7)	(7)	(7)	(7)	(7)
(8)	(8)	(8)	(8)	(8)
(9)	(9)	(9)	(9)	(9)

Decimal answer -4.13				
-	4	.	1	3
.	/	/	/	.
(1)	(1)	(1)	(1)	(1)
(2)	(2)	(2)	(2)	(2)
(3)	(3)	(3)	(3)	(3)
(4)	(4)	(4)	(4)	(4)
(5)	(5)	(5)	(5)	(5)
(6)	(6)	(6)	(6)	(6)
(7)	(7)	(7)	(7)	(7)
(8)	(8)	(8)	(8)	(8)
(9)	(9)	(9)	(9)	(9)

Fraction answer -2/10				
-	2	/	1	0
.	/	/	/	.
(1)	(1)	(1)	(1)	(1)
(2)	(2)	(2)	(2)	(2)
(3)	(3)	(3)	(3)	(3)
(4)	(4)	(4)	(4)	(4)
(5)	(5)	(5)	(5)	(5)
(6)	(6)	(6)	(6)	(6)
(7)	(7)	(7)	(7)	(7)
(8)	(8)	(8)	(8)	(8)
(9)	(9)	(9)	(9)	(9)

Information for Multiple-Choice Questions 1–63

Question 1

Essential Knowledge	2.B.3: Eukaryotic cells maintain internal membranes that partition the cell into specialized regions.
Science Practice	6.2: The student can construct explanations of phenomena based on evidence produced through scientific practices.
Learning Objective	2.13: The student is able to explain how internal membranes and organelles contribute to cell functions.
(A)	This option is incorrect. The presence of organelles will not speed cell reproduction. The need to make new organelles may actually slow the rate of cell division because of the time it takes for the cell to produce them.
(B)	This option is incorrect. Although mitochondria and chloroplasts likely arose from free living prokaryotic cells, this does not explain the advantage for eukaryotic cells to have internal membranes.
(C)	This option is correct. It demonstrates understanding and provides an explanation of how internal membrane-bound organelles contribute to cell function by providing a favorable local environment for metabolic reactions, and by protecting the cell from potentially damaging metabolic reactions.
(D)	This option is incorrect. Compartmentalization does not increase mutation rates. Carrying out potentially harmful reactions within membrane-bound organelles may lower mutation rates because it protects DNA from possible damage.

Question 2

Essential Knowledge	1.D.1: There are several hypotheses about the natural origin of life on Earth, each with supporting scientific evidence.
Science Practice	3.3: The student can evaluate scientific questions.
Learning Objective	1.28: The student is able to evaluate scientific questions based on hypotheses about the origin of life on Earth.
(A)	This option is incorrect. The Miller experiment did not model the formation of Earth but rather attempted to model the evolution of biological molecules on Earth.
(B)	This option is incorrect. The Miller experiment did not model the conditions on comets or meteorites but rather attempted to model the evolution of biological molecules on Earth.
(C)	This option is correct. It demonstrates the ability to evaluate scientific questions about the origin of life on Earth by recognizing that the Miller experiment modeled the presumed early atmospheric conditions and, under laboratory conditions, produced biological molecules, such as amino acids, that were required for early life.
(D)	This option is incorrect. The molecules formed in the Miller experiment were not proteins.

Question 3

Essential Knowledge	2.A.3: Organisms must exchange matter with the environment to grow, reproduce, and maintain organization.
Science Practice	2.2: The student can apply mathematical routines to quantities that describe natural phenomena.
Learning Objective	2.6: The student is able to use calculated surface area-to-volume ratios to predict which cell(s) might eliminate wastes or procure nutrients faster by diffusion.
(A)	This option is correct. It demonstrates the ability to calculate surface area-to-volume ratios and predict their effects on a cell's ability to exchange materials with its environment. The cell shown in A has the greatest surface area-to-volume ratio at 0.6:1.
(B)	This option is incorrect. That cell does not have the greatest surface area-to-volume ratio at 0.3:1.
(C)	This option is incorrect. That cell does not have the greatest surface area-to-volume ratio at 0.2:1.
(D)	This option is incorrect. That cell does not have the greatest surface area-to-volume ratio at 0.1:1.

Question 4

Essential Knowledge	4.B.4: Distribution of local and global ecosystems changes over time.
Science Practice	6.4: The student can make claims and predictions about natural phenomena based on scientific theories and models.
Learning Objective	4.21: The student is able to predict consequences of human actions on both local and global ecosystems.
(A)	This option is correct. It demonstrates an understanding of the human impact on ecosystems and correctly predicts that the loss of habitat from deforestation likely will lead to a loss of species diversity due to a decrease of available niches.
(B)	This option is incorrect. Destruction of the tropical rain forest does not increase soil moisture but rather it decreases soil moisture because there is less shade to retain dampness in deforested regions.
(C)	This option is incorrect. Accumulation of carbon dioxide in the atmosphere does not affect ultraviolet penetration but rather contributes to the “greenhouse effect,” which absorbs reflected infrared radiation and re-reflects some of it back toward Earth, thus warming the planet.
(D)	This option is incorrect. Deforestation would reduce the amount of available oxygen because there would be less photosynthetic activity to release oxygen in the splitting of water in Photosystem II of the light-dependent reactions.

Question 5

Essential Knowledge	1.B.1: Organisms share many conserved core processes and features that evolved and are widely distributed among organisms today.
Science Practice	6.1: The student can justify claims with evidence.
Learning Objective	1.16: The student is able to justify the scientific claim that organisms share many conserved core processes and features that evolved and are widely distributed among organisms today.
(A)	This option is incorrect. Not all populations of organisms are adapted, or can adapt, to fill vacant ecological roles. The ecological role of an organism depends on biotic and abiotic factors in the environment. For example, a carnivore cannot adapt to fill the role of primary producer, and a prey is unlikely to fill the role of a predator.
(B)	This option is incorrect. Not all organisms utilize oxygen to harness free energy from organic compounds. Fermentation and anaerobic respiration provide a mechanism by which some cells can oxidize organic fuel and generate ATP <i>without</i> the use of oxygen. Thus, aerobic respiration is not a universal mechanism for harnessing energy from organic compounds.
(C)	This option is correct. It demonstrates an understanding that all organisms, both extant and extinct, share a universal genetic code with the justification that the hereditary information encoded in DNA directs the development of biochemical, anatomical, and physiological traits by the fundamental processes of replication, transcription, and translation. Through the process of transformation, genetic information from one organism can change the genotype and phenotype of another organism, thus providing additional evidence for the universality of the genetic code.
(D)	This option is incorrect. Only eukaryotic cells possess membrane-bound organelles such as mitochondria and chloroplasts. Although mitochondria and chloroplasts likely arose from symbiotic prokaryotic cells, they are not universal to all cells; neither Bacteria nor Archaea possess membrane-bound organelles.

Question 6

Essential Knowledge	3.A.1: DNA, and in some cases RNA, is the primary source of heritable information.
Science Practice	1.2: The student can describe representations and models of natural or man-made phenomena and systems in the domain.
Learning Objective	3.3: The student is able to describe representations and models that illustrate how genetic information is copied for transmission between generations.
(A)	This option is incorrect. The figure shows both template strands of DNA being replicated continuously in a parallel direction. No “lagging” strand with Okazaki fragments is identified. DNA polymerase’s structure does not allow it to add nucleotides in the 5' direction.
(B)	This option is incorrect. The figure incorrectly shows Okazaki fragments on the “leading” strand and both new strands being assembled in a parallel direction. DNA polymerase’s structure does not allow it to add nucleotides in the 5' direction.
(C)	This option is incorrect. The figure incorrectly shows both strands being replicated continuously, and no Okazaki fragments on the lagging strand are identified. The new strands are shown being assembled in the 3'-to-5' direction, but the limitations of DNA polymerase only allow assembly in the 5'-to-3' direction.
(D)	This option is correct. It demonstrates an understanding of the structure of DNA and the process of replication. The two strands of the DNA molecule run antiparallel to each other; the 5' end of one strand pairs with the 3' end of the other strand. Replication is semi-conservative, with each strand serving as the template for the creation of new complementary strands. Helicase unzips the DNA molecules between the hydrogen bonds connecting the two strands. DNA polymerase “reads” each template strand in the 3'-to-5' direction and assembles the growing DNA chain in a 5'-to-3' direction. The “leading” strand is produced continuously, but on the “lagging” strand, Okazaki fragments are produced and are connected by ligase to produce the daughter molecule.

Question 7

Essential Knowledge	1.C.3: Populations of organisms continue to evolve.
Science Practice	5.3: The student can evaluate the evidence provided by data sets in relation to a particular scientific question.
Learning Objective	1.26: The student is able to evaluate given data sets that illustrate evolution as an ongoing process.
(A)	This option is incorrect. Although the drought period was from 1981 to 1987, data were collected only at the beginning and end of the drought period. In addition, the sample was too small to draw conclusions about the correlation between beak size and seed availability during the drought period.
(B)	This option is incorrect. Although the drought period was from 1981 to 1987, measurements of beak size were determined only for 1987, likely too short a time period to observe/measure evolutionary change. Additionally, the measurements were estimations, and the sample size was small.
(C)	This option is correct. It demonstrates ability to apply the scientific method to evaluate data that illustrate evolution as an ongoing process. Based on observation, the beak sizes of a large number of individuals were measured between the time interval (1981 to 1987) correlating with the period of drought.
(D)	This option is incorrect. Although the drought period was from 1981 to 1987, beak sizes were measured only in 1981. Measurements of offspring beak sizes were determined, not measurements of beak sizes in the original population; thus, comparisons about changes in beak sizes between generations cannot be accurately determined.

Question 8

Essential Knowledge	1.C.3: Populations of organisms continue to evolve.
Science Practice	5.3: The student can evaluate the evidence provided by data sets in relation to a particular scientific question.
Learning Objective	1.26: The student is able to evaluate given data sets that illustrate evolution as an ongoing process.
(A)	This option is correct. It demonstrates understanding of evolution through natural selection and explains the relationship between changes in genotype, phenotype, and environment. During the drought period, plants with thick-walled seeds were favored; in turn, finches with larger beaks that could crack the seeds to obtain nourishment were selected for, thus increasing chances for survival.
(B)	This option is incorrect. There are no data to support this conclusion that draws a correlation between beak size and predatory behavior.
(C)	This option is incorrect. There are no data to support this conclusion that draws a correlation between beak size and flight muscle strength.
(D)	This option is incorrect. Evolution is not explained by Larmack's idea of the inheritance of acquired characters.

Question 9

Essential Knowledge	1.C.3: Populations of organisms continue to evolve.
Science Practice	1.2: The student can describe representations and models of natural or man-made phenomena and systems in the domain.
Learning Objective	1.25: The student is able to describe a model that represents evolution within a population.
(A)	This option is incorrect. The data provide no evidence to support the conclusion that speciation has occurred within the finch population, especially from a single parent species.
(B)	This option is correct. It demonstrates an understanding of the role of natural selection in evolution. Natural selection acts on phenotypic variations in populations. During the drought period the environment favored plants with thick-walled seeds, and finches with larger beaks had a selective advantage over finches with smaller beaks in using the thick-walled seeds as food. More food led to greater reproductive success for the large-beaked finches. Thus, allele frequencies within the finch population changed, with an increase in alleles conferring the more advantageous phenotype — larger beaks. Changes in allele frequencies in a population provide evidence for evolution.
(C)	This option is incorrect. The data provide no evidence to support the conclusion that new alleles appeared in the finch population through mutation. Within the population, there was variation in beak size, and changes in the environment (drought) provided a selective pressure favoring finches with larger beaks to crack thick-walled seeds.
(D)	This option is incorrect. The population is not in Hardy-Weinberg equilibrium because of changes in allele frequencies attributed to natural selection. The population is not in equilibrium because beak size is changing.

Question 10

Essential Knowledge	1.C.3: Populations of organisms continue to evolve.
Science Practice	5.3: The student can evaluate the evidence provided by data sets in relation to a particular scientific question.
Learning Objective	1.26: The student is able to evaluate given data sets that illustrate evolution as an ongoing process.
(A)	This option is incorrect. The data provide no evidence to support this conclusion. The return to pre-drought conditions no longer would favor only plants with thick-walled seeds. With an overall increase in the number of plants due to water availability, there would be more variety in the types of seeds available as a food resource for the finches. Thus, the food supply would be expected to increase, not decrease.
(B)	This option is correct. It demonstrates an ability to evaluate data providing evidence for evolution as an ongoing process. At the end of the drought period, there was a natural return to a variety of seeds available — including a decrease in thick-walled seeds. Thus, allele frequencies shifted to pre-drought numbers because no longer was there selective pressure favoring larger beak sizes.
(C)	This option is incorrect. The data do not support this conclusion. Had drought conditions increased during the time interval (1988–1993), selected pressure would have favored finches with larger beaks to crack open thick-walled seeds.
(D)	This option is incorrect. The data do not support this conclusion. There is no evidence to support a correlation between finch beak size and predator behavior.

Question 11

Essential Knowledge	4.A.1: The subcomponents of biological molecules and their sequence determine the properties of that molecule.
Science Practice	1.3: The student can refine representations and models of natural or man-made phenomena and systems in the domain.
Learning Objective	4.2: The student is able to refine representations and models to explain how the subcomponents of a biological polymer and their sequence determine the properties of that polymer.
(A)	This option is correct. It demonstrates an ability to refine and/or interpret a representation to explain the synthesis of a biological polymer. Peptides or proteins are polymers of amino acid monomers arranged in a unique linear sequence. Each of the 20 amino acids consists of a carbon atom surrounded by an amine group (NH₂), a carboxyl group (COOH), a hydrogen, and an R (variable) group. When two amino acids are positioned so that the carboxyl group of one amino acid backbone is adjacent to the amine group of another amino acid backbone, they can join by a dehydration reaction.
(B)	This option is incorrect. The dipeptide in the figure incorrectly shows a covalent bond between adjacent amine (NH ₂) groups, and the “amino acid” shown is not an amino acid because the molecule lacks an amine group.
(C)	This option is incorrect. The dipeptide in the figure incorrectly shows a covalent bond between adjacent carboxyl (COOH) groups between adjacent amino acids, and the “amino acid” shown is not an amino acid because the molecule lacks a carboxyl group.
(D)	This option is incorrect. Although the dipeptide in the figure shows the formation of a peptide bond between the carboxyl (COOH) group of one amino acid and the amine (NH ₂) group of the adjacent amino acid, the “amino acid” shown to potentially form a tripeptide is not an amino acid because the molecule lacks an amine group.

Question 12

Essential Knowledge	4.A.6: Interactions among living systems and with their environment result in the movement of matter and energy.
Science Practice	1.4: The student can use representations and models to analyze situations or solve problems qualitatively and quantitatively.
Learning Objective	4.15: The student is able to use visual representations to analyze situations or solve problems qualitatively to illustrate how interactions among living systems and with their environment result in the movement of matter and energy.
(A)	This option is incorrect. The quantitative data provided in the scenario do not support this conclusion regarding changes in biomass for coyotes and hawks.
(B)	This option is correct. It demonstrates an understanding of the components of a food web and interactions between all of the participants. Coyotes prey on deer and rabbits, and if developers remove them, coyotes will lose their primary source of nutrition/energy. With this loss of nutrition/energy they will experience a decrease in reproductive success and therefore a significant decline in their population.
(C)	This option is incorrect. The data do not provide evidence to support the conclusion that with the removal of deer and rabbits the coyotes will switch to preying on voles and outcompeting hawks for the energy source.
(D)	This option is incorrect. The vole population may not suffer because there is no longer competition from rabbits and deer for the grass. With the removal of rabbits, hawks will lose a source of energy. However, because hawks also prey on voles whereas coyotes do not, hawks still will have a source of energy.

Question 13

Essential Knowledge	4.A.1: The subcomponents of biological molecules and their sequence determine the properties of that molecule.
Science Practice	6.1: The student can justify claims with evidence.
Learning Objective	4.3: The student is able to use models to predict and justify that changes in the subcomponents of a biological polymer affect the functionality of the molecule.
(A)	This option is incorrect. Although it is true that T (thymine) is not a component of RNA and is replaced by U (uracil), both DNA Segments 1 and 2 must undergo transcription to produce mRNA.
(B)	This option is incorrect. A nucleotide monomer of DNA consists of a phosphate group, deoxyribose, and a nitrogenous base (A, T, C, or G). Although phosphate groups make DNA polar and therefore soluble in water, because both DNA segments have the same number of nucleotide base pairs (11), they have the same number of phosphate groups. Thus, the influence of phosphate groups on both segments' solubility in water is equal.
(C)	This option is correct. It demonstrates an understanding of the relationship between structure and function at the molecular level and the ability to make predictions about how change(s) in structure affect functionality. Because G-C base pairs have three hydrogen bonds, they are more stable structurally. Thus, because DNA Segment 2 has more G-C base pairs than DNA Segment 1, Segment 2 is more stable and thus would denature at <i>higher</i> temperatures than Segment 1.
(D)	This option is incorrect. The structure of DNA is universal to all life, both prokaryotes and eukaryotes. DNA from all organisms consists of both A-T and C-G base pairs.

Question 14

Essential Knowledge	2.D.4: Plants and animals have a variety of chemical defenses against infections that affect dynamic homeostasis.
Science Practice	1.2: The student can describe representations and models of natural or man-made phenomena and systems in the domain.
Learning Objective	2.29: The student can create representations and models to describe immune responses.
(A)	This option is incorrect. Ribosomes do not play a direct role in phagocytosis, although they are organelles that carry out protein synthesis.
(B)	This option is incorrect. Antibodies do not play a role in phagocytosis, a nonspecific immune response. Antibodies are involved in <i>specific</i> immune responses in the presence of specific antigens. Antibodies do not act intracellularly either.
(C)	This option is correct. It demonstrates an understanding to interpret representations that describe a nonspecific immune response. In phagocytosis, a cell engulfs a bacterium by wrapping pseudopodia around it and packaging it within a membrane-enclosed vacuole. The bacterium is digested after the vacuole fuses with a lysosome containing hydrolytic enzymes. Digested particles can be exported out of the cell by exocytosis.
(D)	This option is incorrect. Mitochondria do not play a direct role in cellular digestion. Mitochondria are the sites of cellular respiration, the metabolic process that generates ATP from organic molecules in the presence of oxygen.

Question 15

Essential Knowledge	4.C.4: Diversity of species within an ecosystem may influence the stability of the ecosystem.
Science Practice	6.4: The student can make claims and predictions about natural phenomena based on scientific theories and models.
Learning Objective	4.27: The student is able to make scientific claims and predictions about how species diversity within an ecosystem influences ecosystem stability.
(A)	This option is correct. The other trees shade out the oak trees. Oak seedlings are relatively intolerant to shade. Oak trees need sunlight for photosynthesis, and although they do survive in poor sunlight, they do not proliferate enough to be the dominant plant in the forest. Some oak species need sunlight for full development.
(B)	This option is incorrect for two reasons: First, the shrubs disappear in this progression, so there is no evidence that any change would enhance shrub growth. Second, oak trees do not significantly alter the pH of the soil.
(C)	This option is incorrect because shrubs have relatively small root balls and would not out-compete an oak tree with a deep tap root. When the shrubs disappear, the success of the oak tree does not improve.
(D)	This option is incorrect because there is no evidence in this data of environmental pollutants. Although pollutants do affect oak tree growth, oaks are not considered more sensitive to them than other trees.

Question 16

Essential Knowledge	3.B.1: Gene regulation results in differential gene expression, leading to cell specialization.
Science Practice	1.4: The student can use representations and models to analyze situations or solve problems qualitatively and quantitatively.
Learning Objective	3.21: The student can use representations to describe how gene regulation influences cell products and function.
(A)	This option is incorrect because lactose has bonded with the repressor protein, resulting in its release from the operator. This will allow RNA polymerase to transcribe the lac operon because the molecular barrier no longer exists.
(B)	This option is incorrect because if lactose did bind with the repressor protein, then it would result in a conformational change and the repressor protein would no longer bind to the operator portion of the operon. No transcription would occur.
(C)	This option is incorrect because with no repressor in place, the operon would be turned on, and the genes would be transcribed.
(D)	This option is correct because the lac operon is an inducible operon, which means that the regulatory system is turned off until lactose or its analog turns it on. The mechanism for preventing its transcription is the binding of a repressor protein to the operator region.

Question 17

Essential Knowledge	2.A.2: Organisms capture and store free energy for use in biological processes. 2.D.1: All biological systems from cells and organisms to populations, communities, and ecosystems are affected by complex biotic and abiotic interactions involving exchange of matter and free energy.
Science Practice	6.2: The student can construct explanations of phenomena based on evidence produced through scientific practices.
Learning Objective	2.5: The student is able to construct explanations of the mechanisms and structural features of cells that allow organisms to capture, store, or use free energy.
(A)	This option is correct. There is no change in gas volume measured by the respirometer unless carbon dioxide is removed, because oxygen is consumed at the same rate that carbon dioxide is produced during cellular respiration.
(B)	This option is incorrect because the production of oxygen by plants is by the process of photosynthesis, which is not the focus of this experiment. The focus of this experiment is the consumption of oxygen during aerobic cellular respiration, not the production of oxygen gas during photosynthesis.
(C)	This option is incorrect because a glucose reserve would have no effect on the measurement of oxygen gas consumption because the oxidation of glucose via aerobic cellular respiration would still consume oxygen gas at the same rate as carbon dioxide production.
(D)	This option is incorrect because the release of excess water would have no effect on the relative volumes of oxygen or carbon dioxide gas. There would not be enough water produced in this experiment to affect gas volume due to differences in solubility.

Question 18

Essential Knowledge	2.A.2: Organisms capture and store free energy for use in biological processes.
Science Practice	6.2: The student can construct explanations of phenomena based on evidence produced through scientific practices.
Learning Objective	2.5: The student is able to construct explanations of the mechanisms and structural features of cells that allow organisms to capture, store, or use free energy.
(A)	This option is correct. Mice are endotherms and at cold temperatures will increase their rate of ATP production in order to shiver. This increase in metabolism will produce heat according to the second law of thermodynamics. This heat production will help the mouse maintain a constant internal environment.
(B)	This option is incorrect because a lower metabolic rate would mean a lower consumption of oxygen. The data do not support this claim. The mouse consumed more oxygen at 10°C than at 25°C.
(C)	This option is incorrect because the data for oxygen consumption were controlled for by mass / weight. All numbers are mL/g.
(D)	This option is incorrect because the data do not support this claim. If the mice were more active at the higher temperature, then they would have consumed more oxygen. More activity would require more ATP, which is produced by aerobic cellular respiration in mice.

Question 19

Essential Knowledge	2.A.1: All living systems require constant input of free energy. 2.A.2: Organisms capture and store free energy for use in biological processes.
Science Practice	6.2: The student can construct explanations of phenomena based on evidence produced through scientific practices.
Learning Objective	2.1: The student is able to explain how biological systems use free energy based on empirical data that all organisms require constant energy input to maintain organization, to grow, and to reproduce.
(A)	This option is incorrect because the rate of oxygen consumption is due to metabolic rates since oxygen is necessary for ATP production. Though size does affect heat gain and loss due to surface area to volume ratios, this physical trait would have the same effect in both organisms, not the opposite.
(B)	This option is incorrect because both crickets and mice are chemoheterotrophs.
(C)	This option is correct because crickets are ectotherms. Ectotherms have very low metabolic rates, so they depend on the environment to help regulate their internal temperature. Therefore, crickets would have a higher metabolic rate at the higher temperature due to kinetics or more frequent molecular collisions.
(D)	This option is incorrect because both organisms produce ATP via aerobic cellular respiration when oxygen is not a limiting reactant.

Question 20

Essential Knowledge	1.B.1: Organisms share many conserved core processes and features that evolved and are widely distributed among organisms today.
Science Practice	7.2: The student can connect concepts in and across domain(s) to generalize or extrapolate in and/or across enduring understandings and/or big ideas.
Learning Objective	1.15: The student is able to describe specific examples of conserved core biological processes and features shared by all domains or within one domain of life, and how these shared, conserved core processes and features support the concept of common ancestry for all organisms.
(A)	This option is incorrect because there are no reference organisms described that share this common ancestor. Chloroplasts evolved from endosymbiotic prokaryotes, and this places the evolutionary connection at an earlier pre-eukaryotic stage. The data do not support the claim that FtsZ and tubulin were present in a common ancestor.
(B)	This option is incorrect because microtubules have no direct involvement in photosynthesis. Even if there is some indirect involvement, this claim does not support the relationship between tubulin proteins in eukaryotes and FtsZ proteins in prokaryotes and chloroplasts.
(C)	This option is correct. The evidence states that the FtsZ gene is present in prokaryotes and in chloroplasts. Chloroplasts evolved from endosymbiotic prokaryotes. The tubulin protein is structurally and functionally similar to FtsZ and is found in eukaryotes, inferring evolutionary descent.
(D)	This option is incorrect because there is no evidence that the genes encoding FtsZ protein and tubulin are identical. In fact, the data state that the proteins are structurally similar, which implies some variance, which also would require a variance in gene sequences.

Question 21

Essential Knowledge	2.D.2: Homeostatic mechanisms reflect both common ancestry and divergence due to adaptation in different environments.
Science Practice	7.1: The student can connect phenomena and models across spatial and temporal scales.
Learning Objective	2.27: The student is able to connect differences in the environment with the evolution of homeostatic mechanisms.
(A)	This option is incorrect because fish, along with all organisms, consume food containing proteins and nucleic acids — both nitrogenous compounds.
(B)	This option is correct. There is no need to convert ammonia to urea because it can be excreted often in dilute, nontoxic concentrations. This process requires less energy than the additional step of urea conversion. Dehydration due to water loss is not a problem for freshwater fish because water is plentiful.
(C)	This option is incorrect because ammonia is not concentrated in tissues for storage; this would be toxic to those cells.
(D)	This option is incorrect because the nitrogen in ammonia is not recycled; it is so toxic that fish need to get rid of it quickly. In addition, animals do not possess the ability to recycle ammonia, most likely due to the lack of enzymes capable of catalyzing this reaction.

Question 22

Essential Knowledge	3.C.3: Viral replication results in genetic variation, and viral infection can introduce genetic variation into the hosts.
Science Practice	1.4: The student can use representations and models to analyze situations or solve problems qualitatively and quantitatively.
Learning Objective	3.30: The student is able to use representations and appropriate models to describe how viral replication introduces genetic variation in the viral population.
(A)	This option is incorrect because the virus particle does not get damaged during the infection stage. Although the viral envelope fuses with the host cell membrane, the virus particle is not damaged during the process of infection.
(B)	This option is correct. The process of reverse transcription does not involve proofreading.
(C)	This option is incorrect. The host cell provides the nucleotides for making viral nucleic acids, as well as enzymes, ribosomes, tRNAs, amino acids, ATP, polymerases, and other components needed for synthesizing viral proteins. Thus, using host machinery, viral DNA is translated effectively.
(D)	This option is incorrect. Retroviral genes are incorporated into the host cell's DNA and are transcribed into RNA molecules, which serve as genomes for the next viral generation and as mRNAs for translation into viral protein. The integrated viral DNA remains part of the host's genome.

Question 23

Essential Knowledge	2.B.2: Growth and dynamic homeostasis are maintained by the constant movement of molecules across membranes.
Science Practice	1.4: The student can use representations and models to analyze situations or solve problems qualitatively and quantitatively.
Learning Objective	2.12: The student is able to use representations and models to analyze situations or solve problems qualitatively and quantitatively to investigate whether dynamic homeostasis is maintained by the active movement of molecules across membranes.
(A)	This option is incorrect because the cells would shrink in a hypertonic solution, not a physiological saline solution, which means the solution is isotonic to a normal RBC.
(B)	This option is incorrect because RBCs do not have the ability to pump water out. Red blood cells lack internal membrane-bound organelles.
(C)	This option is correct. The saline solution is isotonic relative to the RBC's cytoplasm. This will result in a dynamic equilibrium. View 2 shows a RBC in an isotonic environment because it would shrink in a hypertonic solution and swell in a hypotonic solution.
(D)	This option is incorrect because the sodium potassium pump actually pumps out more sodium than potassium, which would make the internal environment of the RBC hypotonic and thus lose water and shrink, not gain water and swell. In addition, sodium potassium pumps do not play a role in osmosis across cell membranes.

Question 24

Essential Knowledge	2.A.1: All living systems require constant input of free energy.
Science Practice	6.1: The student can justify claims with evidence.
Learning Objective	2.2: The student is able to justify a scientific claim that free energy is required for living systems to maintain organization, to grow, or to reproduce, but that multiple strategies exist in different living systems.
(A)	This option is incorrect despite being a correct statement. These strategies help the different organisms to survive cold periods but are not metabolic strategies for meeting their energy needs.
(B)	This option is incorrect because this fact comparing bacterial and eukaryotic genomes and the presence of introns has nothing to do with these organisms meeting their energy needs by varying metabolic strategies.
(C)	This option is incorrect. Metabolism is defined as the totality of an organism's chemical reactions. The type of teeth organisms have would not be considered a metabolic strategy but rather a structural strategy.
(D)	This option is correct. Starch, glycogen, and fat are all molecules used for energy storage, yet plants have evolved to use starch while animals have evolved to use fat for long-term energy storage and glycogen for short-term energy storage.

Question 25

Essential Knowledge	2.B.2: Growth and dynamic homeostasis are maintained by the constant movement of molecules across membranes.
Science Practice	1.4: The student can use representations and models to analyze situations or solve problems qualitatively and quantitatively.
Learning Objective	2.12: The student is able to use representations and models to analyze situations or solve problems qualitatively and quantitatively to investigate whether dynamic homeostasis is maintained by the active movement of molecules across membranes.
(A)	This option is incorrect because the paramecium's plasma membrane is not permeable to charged ions, so no salt will enter. If salt could enter the paramecium, then water would follow by osmosis and actually result in increasing contractions of the contractile vacuole.
(B)	This option is correct. The lower the concentration of solute, the larger the gradient between the paramecium and the solution. When the paramecium is hypertonic to the low concentration solution, water will enter the paramecium by osmosis. If the paramecium does not pump excess water back out, it will burst. As the solution gradient decreases, less water will enter, and, therefore, there will be a decreased need to pump excess water out.
(C)	This option is incorrect because the external concentration of salt has no direct relationship with internal ATP production by cellular respiration. As long as the paramecium's internal environment is not altered, then cellular respiration should be unaffected, and therefore the contractile vacuole will have sufficient energy.
(D)	This option is incorrect because even at isosmotic concentrations water still diffuses, but in dynamic equilibrium.

Question 26

Essential Knowledge	2.D.1: All biological systems from cells and organisms to populations, communities, and ecosystems are affected by complex biotic and abiotic interactions involving exchange of matter and free energy.
Science Practice	5.1: The student can analyze data to identify patterns or relationships.
Learning Objective	2.24: The student is able to analyze data to identify possible patterns and relationships between a biotic or abiotic factor and a biological system (cells, organisms, populations, communities, or ecosystems).
(A)	This option is correct. Dish B, which was uncovered, had 20 seeds germinate, while the covered dish A had only 12 seeds germinate in the first week.
(B)	This option is incorrect because the only variable was light intensity, and dish B did have more seeds germinate when exposed to light versus only 12 seeds in dish A, which was not exposed to light.
(C)	This option is incorrect because both dishes had paper towels — the paper towels were a controlled variable.
(D)	This option is incorrect. Germination occurred more rapidly in the yellow-leaved seedlings in dish A and at the same rate in dish B, so the data do not support the claim that germination was accelerated in green-leaved seedlings.

Question 27

Essential Knowledge	2.D.1: All biological systems from cells and organisms to populations, communities, and ecosystems are affected by complex biotic and abiotic interactions involving exchange of matter and free energy.
Science Practice	5.1: The student can analyze data to identify patterns or relationships.
Learning Objective	2.24: The student is able to analyze data to identify possible patterns and relationships between a biotic or abiotic factor and a biological system (cells, organisms, populations, communities, or ecosystems).
(A)	This option is incorrect. Shortening of cells in response to a lack of light would result in slower growth, but this claim is not supported by the data.
(B)	This option is correct. In response to the lack of light, the plant elongates cells in an attempt to reach light necessary for photosynthesis at the expense of leaf development.
(C)	This option is incorrect. In the seeds that were exposed to light, the plants actually grew more slowly, so enhancement of stem elongation is not supported by the data.
(D)	This option is incorrect because genetic differences were accounted for by using 20 seeds each from the same species.

Question 28

Essential Knowledge	3.C.1: Changes in genotype can result in changes in phenotype.
Science Practice	7.2: The student can connect concepts in and across domain(s) to generalize or extrapolate in and/or across enduring understandings and/or big ideas.
Learning Objective	3.26: The student is able to explain the connection between genetic variations in organisms and phenotypic variations in populations.
(A)	This option is incorrect because the leaves in dish A could have been yellow because they had not been exposed to light yet and could have changed to green in response to light, which would not be a genetic difference. Some yellow leaves did change to green when exposed to light.
(B)	This option is incorrect because the only variable in this experiment was light. If genes responsible for leaf color also had an impact on germination rate, then germination should have been similar in each dish, which is not supported.
(C)	This option is incorrect because according to the data, no seedlings died.
(D)	This option is correct because both colors of leaves existed after 14 days and essentially in the same numbers. If the green color resulted from a response to light, then the yellow leaves would have changed to green by 14 days.

Question 29

Essential Knowledge	2.D.1: All biological systems from cells and organisms to populations, communities, and ecosystems are affected by complex biotic and abiotic interactions involving exchange of matter and free energy.
Science Practice	7.2: The student can connect concepts in and across domain(s) to generalize or extrapolate in and/or across enduring understandings and/or big ideas.
Learning Objective	2.23: The student is able to design a plan for collecting data to show that all biological systems (cells, organisms, populations, communities, and ecosystems) are affected by complex biotic and abiotic interactions.
(A)	This option is incorrect because there is no evidence that yellow seedlings were unable to absorb water between days 14–21. In addition, because the seedlings were capable of doing so during the first 14 days, there is no evidence to support this claim that they could not absorb water <i>after</i> day 14.
(B)	This option is incorrect because there is no evidence that green seedlings were taller.
(C)	This option is correct. The only difference between the two plants after day 14 was the leaf color. Without chlorophyll, the yellow seedlings could not absorb enough light energy to convert to chemical energy to sustain growth. Therefore, no yellow seedlings were found alive in either dish after day 21.
(D)	This option is incorrect because there are no data supporting a higher rate of respiration in yellow seedlings compared to green seedlings.

Question 30

Essential Knowledge	4.C.2: Environmental factors influence the expression of the genotype in an organism.
Science Practice	6.2: The student can construct explanations of phenomena based on evidence produced through scientific practices.
Learning Objective	4.23: The student is able to construct explanations of the influence of environmental factors on the phenotype of an organism.
(A)	This option is correct. It demonstrates the ability to explain the influence of environmental factors on the phenotype of an organism. When the genes of the arctic fox that produce the dark coat are blocked by cold temperatures, a white coat results. In the summer these genes are not blocked, and a darker coat results.
(B)	This option is incorrect. The diet of the foxes in the summer or winter, regardless of whether it lacks a particular nutrient, would not cause a coat color change. In addition, the diet of the foxes in the summer is more likely to be better in terms of nutrients than in the winter.
(C)	This option is incorrect. Competition for mates and the increase in camouflage in the spring are not responsible for the seasonal change in coat color. Competition for mates generally involves being noticed, not camouflaged.
(D)	This option is incorrect. Cold temperatures do not denature pigment molecules.

Question 31

Essential Knowledge	2.C.1: Organisms use negative feedback mechanisms to maintain their internal environments and respond to external environmental changes.
Science Practice	7.2: The student can connect concepts in and across domain(s) to generalize or extrapolate in and/or across enduring understandings and/or big ideas.
Learning Objective	2.16: The student is able to connect how organisms use negative feedback to maintain their internal environments.
(A)	This option is incorrect. The onset of labor is an example of a positive feedback mechanism, not a negative feedback mechanism.
(B)	This option is correct. The decrease of blood glucose levels as a result of insulin production is an example of how the endocrine system is involved in negative feedback, allowing organisms to maintain their internal environments.
(C)	This option is incorrect. Respiration rates would increase, not decrease, in response to low oxygen levels.
(D)	This option is incorrect. Transcription factors are not part of the endocrine system.

Question 32

Essential Knowledge	1.B.2: Phylogenetic trees and cladograms are graphical representations (models) of evolutionary history that can be tested.
Science Practice	1.1: The student can create representations and models of natural or man-made phenomena and systems in the domain.
Learning Objective	1.19: The student is able create a phylogenetic tree or simple cladogram that correctly represents evolutionary history and speciation from a provided data set.
(A)	This option is incorrect. The nucleotide differences between species 5 and 1 in the data set are high and do not represent a close relationship.
(B)	This option is incorrect. Even though the nucleotide differences between species 5 and 3 in the data set show a close relationship, species 3 and 4 have fewer differences and thus are closer in their evolutionary history.
(C)	This option is correct. It demonstrates the ability to select the phylogenetic tree that correctly represents evolutionary history and speciation from the data set. The data indicate that species 5 is not closely related to the others and that 3 and 4 are very closely related. This cladogram incorporates those differences as well as the close relationship between 1 and 2.
(D)	This option is incorrect. The nucleotide differences in species 2 are closer to species 1, and this representation indicates they are linked evolutionarily to all the other species.

Question 33

Essential Knowledge	3.D.4: Changes in signal transduction pathways can alter cellular response.
Science Practice	6.1: The student can justify claims with evidence.
Learning Objective	3.37: The student is able to justify claims based on scientific evidence that changes in signal transduction pathways can alter cellular response.
(A)	This option is incorrect. The absorption of a mineral is not part of a signal transduction pathway.
(B)	This option is correct. The student is asked to justify the claim that changes in signal transduction pathways can alter cellular response. Second messengers are involved in signal transduction pathways, and if the second messenger is not present, the pathway is blocked.
(C)	This option is incorrect. A mutagen would cause a change in the DNA, not the signal transduction pathway.
(D)	This option is incorrect. Transcription of ribosomal RNA is not part of a signal transduction pathway.

Question 34

Essential Knowledge	2.E.1: Timing and coordination of specific events are necessary for the normal development of an organism, and these events are regulated by a variety of mechanisms.
Science Practice	1.4: The student can use representations and models to analyze situations or solve problems qualitatively and quantitatively.
Learning Objective	2.32: The student is able to use a graph or diagram to analyze situations or solve problems (quantitatively or qualitatively) that involve timing and coordination of events necessary for normal development in an organism.
(A)	This option is correct. The second indicates that, after fertilization, the concentration of the bicoid protein decreases as the concentration of the caudal protein increases. Inhibition of the translation of caudal protein by bicoid protein is a logical hypothesis about the interaction of these two proteins and supports the concept that both the coordination and timing of these two proteins are necessary for the normal development in a <i>Drosophila</i> egg.
(B)	This option is incorrect. There is no indication that the bicoid protein stabilizes caudal DNA. The first graph shows the relative concentrations of mRNA for the two proteins; the second shows the relative concentration of the proteins.
(C)	This option is incorrect. There are not enough data to support that translation of bicoid mRNA produces caudal protein.
(D)	This option is incorrect. The second graph shows that caudal protein stimulates the development of posterior structures, not anterior structures, as indicated in the graph.

Question 35

Essential Knowledge	3.C.2: Biological systems have multiple processes that increase genetic variation.
Science Practice	7.2: The student can connect concepts in and across domain(s) to generalize or extrapolate in and/or across enduring understandings and/or big ideas.
Learning Objective	3.27: The student is able to compare and contrast processes by which genetic variation is produced and maintained in organisms from multiple domains.
(A)	This option is incorrect. Crossing over would not lead to a change in the genetic information within a strain.
(B)	This option is incorrect. Viruses do not contain genes for synthesis pathways.
(C)	This option is incorrect. Random assortment of chromosomes does not lead to genetic variation in the population.
(D)	This option is correct. The most likely source of genetic variation found in the tryptophan synthesis pathways of both species would have occurred primarily with the imperfect nature of DNA replication, which could have led to an increase in genetic variation in both species.

Question 36

Essential Knowledge	4.A.1: The subcomponents of biological molecules and their sequence determine the properties of that molecule.
Science Practice	7.1: The student can connect phenomena and models across spatial and temporal scales.
Learning Objective	4.1: The student is able to explain the connection between the sequence and subcomponents of a biological polymer and its properties.
(A)	This option is correct. The mutation results in the replacement of an amino acid, which alters the properties of the R-group both structurally and functionally; thus, the interactions between adjacent hemoglobin molecules would also be altered. In this case, hemoglobin molecules would tend to stick together as a result of hydrophobic interactions between amino acids on the surface.
(B)	This option is incorrect. A point mutation, which causes the replacement of an amino acid with another amino acid, has already occurred in the DNA. The replacement of one amino acid would not alter the hydrogen bonding between nitrogenous bases in the structure of DNA.
(C)	This option is incorrect. A point mutation, which causes the replacement of a hydrophilic amino acid R-group with another amino acid that has a hydrophobic R-group, would not alter a fatty acid.
(D)	This option is incorrect. A mutation is not likely to alter the secondary structure of a protein. The secondary structure of proteins is due to hydrogen bonding between the carboxyl and amine residues in the chain, not interactions between R-groups.

Question 37

Essential Knowledge	1.A.4: Biological evolution is supported by scientific evidence from many disciplines, including mathematics.
Science Practice	1.1: The student can create representations and models of natural or man-made phenomena and systems in the domain.
Learning Objective	1.13: The student is able to construct and/or justify mathematical models, diagrams, or simulations that represent processes of biological evolution.
(A)	This option is incorrect. The population of beetles after pollution would not have shifted to a more light-colored beetle as indicated in diagram I because the tree trunks would have been darker, and the lighter colored beetles would have been eaten by predators more easily since they were light and the trees were dark. The suggestion that the predators would find the darker tree trunks more easily is irrelevant.
(B)	This option is incorrect. After the pollution the coloration could not have split into two groups because the lighter colored beetles would not have been able to hide on the darker tree trunks and thus would have been preyed upon.
(C)	This option is incorrect. The coloration range after pollution would not have become narrower, as in diagram III, because predators were selecting those light-colored beetles that were distinguishable on the darker tree trunks.
(D)	This option is correct because it illustrates the change in the population that would occur with selection against the lighter colored beetles. The student is asked to justify and explain the process of biological evolution in this question. A change in coloration of the beetle population after pollution is shown in diagram IV because the original beetles (lighter colored beetles) were eaten by predators, and the darker colored beetles would have survived.

Question 38

Essential Knowledge	4.C.2: Environmental factors influence the expression of the genotype in an organism.
Science Practice	6.2: The student can construct explanations of phenomena based on evidence produced through scientific practices.
Learning Objective	4.23: The student is able to construct explanations of the influence of environmental factors on the phenotype of an organism.
(A)	This option is incorrect. Environmental contamination in Lake Apopka had a negative effect on the enzyme in females by decreasing the activity, not increasing the activity, as in Lake Woodruff, which was not contaminated.
(B)	This option is correct. In Lake Woodruff, the lake that is relatively pristine, females had high levels of oxido-reductase enzyme activity, but in Lake Apopka, where environmental contamination conditions were severe, the enzyme activity was low, indicating that environmental factors had an influence on the organism.
(C)	This option is incorrect. Environmental contamination in both lakes did not seem to influence the enzyme for activity for males.
(D)	This option is incorrect. Environmental contamination in both lakes did not seem to influence the enzyme for activity for males.

Question 39

Essential Knowledge	2.D.4: Plants and animals have a variety of chemical defenses against infections that affect dynamic homeostasis.
Science Practice	1.2: The student can describe representations and models of natural or man-made phenomena and systems in the domain.
Learning Objective	2.29: The student can create representations and models to describe immune responses.
(A)	This option is correct. The graph correctly represents the humoral immune response of an organism to the same antigen more than once. Memory cells created after the first exposure result in a more rapid response in subsequent exposures with a greater amount of the antibody.
(B)	This option is incorrect. The graph shows that the amount of antibody during the first exposure is twice as much as the second exposure, whereas the second exposure to the antigen should show results that have a rapid increase in the amount of antibody.
(C)	This option is incorrect. The graph shows that during the first antigen exposure the antibody increased and remained at a high level, which is not what happens in an individual's humoral response.
(D)	This option is incorrect. The graph shows that during the first antigen exposure the antibody increased and then remained at a high level. Increasing further after the second exposure is not what we would predict with an individual's humoral response.

Question 40

Essential Knowledge	3.C.2: Biological systems have multiple processes that increase genetic variation.
Science Practice	6.2: The student can construct explanations of phenomena based on evidence produced through scientific practices.
Learning Objective	3.28: The student is able to construct an explanation of the multiple processes that increase variation within a population.
(A)	This option is incorrect. Plate I shows an extensive growth of bacteria, which is normal when wild-type <i>E. coli</i> is grown without ampicillin. There was no selection for ampicillin resistance; thus, this plate served as a control.
(B)	This option is incorrect. Plate III shows <i>E. coli</i> and the ampicillin-resistant plasmid growing extensively when no ampicillin is present. Indication of which bacteria took up the naked DNA with the <i>amp^r</i> gene is undetermined.
(C)	This option is correct. Plate IV shows that only <i>E. coli</i> with the plasmid containing the gene for ampicillin-resistant plasmid grew individual colonies with ampicillin in the agar, thus showing the competent cells that transformed successfully.
(D)	This option is incorrect. Plate II shows that there is no bacterial growth when ampicillin is present; thus, there are no ampicillin-resistant bacteria.

Question 41

Essential Knowledge	3.C.2: Biological systems have multiple processes that increase genetic variation.
Science Practice	6.2: The student can construct explanations of phenomena based on evidence produced through scientific practices.
Learning Objective	3.28: The student is able to construct an explanation of the multiple processes that increase variation within a population.
(A)	This option is correct. The initial wild-type <i>E. coli</i> did not contain the plasmid containing the gene for resistance to the ampicillin (<i>amp^r</i>) and, when exposed to ampicillin, did not grow on Plate II.
(B)	This option is incorrect. In a typical transformation experiment, if all procedures were followed as in this experiment, it is unlikely for a procedure to kill the bacteria. Plate IV indicates that the transformation procedure did not kill the bacteria.
(C)	This option is incorrect. Nutrient agar promotes <i>E. coli</i> growth.
(D)	This option is incorrect. The bacteria in Plate II were not exposed to the plasmid and thus could not have been transformed.

Question 42

Essential Knowledge	3.C.2: Biological systems have multiple processes that increase genetic variation.
Science Practice	6.2: The student can construct explanations of phenomena based on evidence produced through scientific practices.
Learning Objective	3.28: The student is able to construct an explanation of the multiple processes that increase variation within a population.
(A)	This option is correct. Both Plates I and III had extensive <i>E. coli</i> growth, showing that the cells were viable before and after the transformation procedure.
(B)	This option is incorrect. Plates I and III would not have provided information on whether the plasmid could lose its <i>amp^r</i> gene, and there was no way of knowing this with the data from these two plates.
(C)	This option is incorrect. The bacteria in Plate I were not exposed to the plasmid.
(D)	This option is incorrect. The bacteria were plated after the transformation; thus, plating could not have prepared them for transformation.

Question 43

Essential Knowledge	3.C.2: Biological systems have multiple processes that increase genetic variation.
Science Practice	6.2: The student can construct explanations of phenomena based on evidence produced through scientific practices.
Learning Objective	3.28: The student is able to construct an explanation of the multiple processes that increase variation within a population.
(A)	This option is incorrect. Plate I is the positive control, showing that the bacteria were viable before the transformation procedure.
(B)	This option is correct. Only the <i>E. coli</i> that have been transformed and contain the <i>amp^r</i> gene will grow and produce colonies.
(C)	This option is incorrect. The transformation experiment did not determine whether <i>E. coli</i> bacteria could mutate or not.
(D)	This option is incorrect. Both plates with plasmids showed growth while the plate with ampicillin and no plasmids showed no growth, indicating that plasmids did not inhibit growth.

Question 44

Essential Knowledge	3.C.2: Biological systems have multiple processes that increase genetic variation.
Science Practice	6.2: The student can construct explanations of phenomena based on evidence produced through scientific practices.
Learning Objective	3.28: The student is able to construct an explanation of the multiple processes that increase variation within a population.
(A)	This option is incorrect. The bacteria in Plate I were not exposed to the plasmid.
(B)	This option is incorrect. Plate III does not distinguish which bacteria took up the plasmid. Bacteria with and without the plasmid grow, but the percentage of those with the ability to produce insulin is much lower than in Plate IV.
(C)	This option is correct. In Plate IV the colonies of <i>E. coli</i> were successfully transformed and expressed the <i>amp^r</i> gene; adding another gene to the plasmid would express the human insulin gene the same way.
(D)	This option is incorrect. The bacteria on Plate I were not exposed to the plasmid and so could not have taken up the insulin gene, thus eliminating this choice.

Question 45

Essential Knowledge	1.B.1: Organisms share many conserved core processes and features that evolved and are widely distributed among organisms today.
Science Practice	7.2: The student can connect concepts in and across domain(s) to generalize or extrapolate in and/or across enduring understandings and/or big ideas.
Learning Objective	1.15: The student is able to describe specific examples of conserved core biological processes and features shared by all domains or within one domain of life, and how these shared, conserved core processes and features support the concept of common ancestry for all organisms.
(A)	This option is incorrect. Glycolysis does not occur in the mitochondria. Archaea and Bacteria do not contain mitochondria.
(B)	This option is correct because it demonstrates understanding of the processes of evolution and glycolysis, which is common to both aerobic and anaerobic respiration.
(C)	This option is incorrect. Many organisms rely on aerobic respiration for ATP production.
(D)	This option is incorrect. There is no evidence for any other energy-producing process that substitutes for and predates glycolysis.

Question 46

Essential Knowledge	2.E.1: Timing and coordination of specific events are necessary for the normal development of an organism, and these events are regulated by a variety of mechanisms.
Science Practice	7.1: The student can connect phenomena and models across spatial and temporal scales.
Learning Objective	2.34: The student is able to describe the role of programmed cell death in development and differentiation, the reuse of molecules, and the maintenance of dynamic homeostasis.
(A)	This option is correct. It demonstrates understanding of dynamic homeostasis in the reuse of nutrients by the body in development.
(B)	This option is incorrect. Shedding the tail in this stage of development is not necessary to conserve energy.
(C)	This option is incorrect. The tail does not divide bilaterally during development.
(D)	This option is incorrect. There is no evidence that cells of the tail migrate to gonads.

Question 47

Essential Knowledge	1.A.2: Natural selection acts on phenotypic variations in populations.
Science Practice	7.1: The student can connect phenomena and models across spatial and temporal scales.
Learning Objective	1.5: The student is able to connect evolutionary changes in a population over time to a change in the environment.
(A)	This option is incorrect. It implies that evolution occurs according to “need,” or in order to cause a certain outcome.
(B)	This option is incorrect because it is contrary to fact; the plasmid does not confer resistance to the new antibiotic.
(C)	This option is correct. It demonstrates an understanding that the plasmid would remain in the population even though it is not favored by selection and because it is not being selected against.
(D)	This option is incorrect because the methicillin-resistance plasmid does not confer any resistance to the new antibiotic in bacteria.

Question 48

Essential Knowledge	3.D.3: Signal transduction pathways link signal reception with cellular response.
Science Practice	1.5: The student can re-express key elements of natural phenomena across multiple representations in the domain.
Learning Objective	3.36: The student is able to describe a model that expresses the key elements of signal transduction pathways by which a signal is converted to a cellular response.
(A)	This option is incorrect. ADH stimulates the production of aquaporins. Inhibition of ADH would result in fewer aquaporins.
(B)	This option is incorrect because inhibition of ADH causes more water to be excreted from the body, thus triggering thirst rather than decreasing it.
(C)	This option is incorrect because filtration of the blood in the kidney is independent of ADH.
(D)	This option is correct because it links the signal (ADH) with the response (reabsorption of water). Because ADH increases reabsorption of water, its lack would result in less water reabsorbed, more excreted, and thus a more dilute urine.

Question 49

Essential Knowledge	2.E.1: Timing and coordination of specific events are necessary for the normal development of an organism, and these events are regulated by a variety of mechanisms.
Science Practice	1.4: The student can use representations and models to analyze situations or solve problems qualitatively and quantitatively.
Learning Objective	2.32: The student is able to use a graph or diagram to analyze situations or solve problems (quantitatively or qualitatively) that involve timing and coordination of events necessary for normal development in an organism.
(A)	This option is correct. The stem of the question indicates that cell 4 and cell 3 must be touching in order for cell 3 to induce formation of the intestine. This is the mechanism by which the correct timing of this developmental event occurs.
(B)	This option is incorrect because there is no indication that microvilli are formed.
(C)	This option is incorrect because there is no evidence of an electrical signal.
(D)	This option is incorrect because there is no indication that genetic material is transferred from cell 4 to cell 3, resulting in the development of intestinal cells.

Question 50

Essential Knowledge	3.A.2: In eukaryotes, heritable information is passed to the next generation via processes that include the cell cycle, mitosis, or meiosis plus fertilization.
Science Practice	5.3: The student can evaluate the evidence provided by data sets in relation to a particular scientific question.
Learning Objective	3.11: The student is able to evaluate evidence provided by data sets to support the claim that heritable information is passed from one generation to another generation through mitosis, or meiosis followed by fertilization.
(A)	This option is incorrect because if the environment determined the flower color, then the occasional white and pink flower would not be seen in the original environment.
(B)	This option is incorrect because there is no indication of the stages of flower development, and the 3:1 ratios in the first two crosses would not be seen if the stage of flower development were the controlling factor.
(C)	This option is incorrect because the crosses of blue and white and blue and pink do fit expected phenotypic ratios. Vegetative propagation would not result in the ratios indicated by the data.
(D)	This option is correct. The student is asked to evaluate the data given. The crosses between blue / white and blue / pink show expected 3:1 ratios in the F₁ generation. The appearance of a majority of blue flowers in the F₁ cross between pink and white indicate that there is another gene product affecting the outcome.

Question 51

Essential Knowledge	4.B.1: Interactions between molecules affect their structure and function.
Science Practice	5.1: The student can analyze data to identify patterns or relationships.
Learning Objective	4.17: The student is able to analyze data to identify how molecular interactions affect structure and function.
(A)	This option is incorrect. The graph shows that myoglobin does bind oxygen at 10 mm Hg partial pressure.
(B)	This option is incorrect. At 20 mm Hg partial pressure myoglobin is nearly saturated with oxygen, whereas hemoglobin is only about 10 percent saturated.
(C)	This option is correct. The question tests whether the student can read the graph to analyze the data. The graph indicates that at 40 mm Hg pressure, myoglobin binds a greater amount of oxygen than hemoglobin.
(D)	This option is incorrect because the saturation of both hemoglobin and myoglobin with oxygen is nearly equal.

Question 52

Essential Knowledge		4.B.1: Interactions between molecules affect their structure and function.
Science Practice		5.1: The student can analyze data to identify patterns or relationships.
Learning Objective		4.17: The student is able to analyze data to identify how molecular interactions affect structure and function.
(A)	This option is correct. If the curve shifts to the right, both hemoglobin and myoglobin are less saturated at a given partial pressure of oxygen, thus indicating that the oxygen has been unloaded. This answer reflects the claim that the student can analyze the data to identify how molecular interactions (H⁺ and myoglobin) affect function (binding of O₂).	
(B)	This option is incorrect because an increase in binding sites would increase, not decrease, binding.	
(C)	This option is incorrect because the capture of more oxygen would increase, not decrease, binding. The curve would not be shifted to the right.	
(D)	This option is incorrect because the capture of more oxygen would increase, not decrease, binding. The curve would not be shifted to the right.	

Question 53

Essential Knowledge		4.B.1: Interactions between molecules affect their structure and function.
Science Practice		5.1: The student can analyze data to identify patterns or relationships.
Learning Objective		4.17: The student is able to analyze data to identify how molecular interactions affect structure and function.
(A)	This option is incorrect. The higher affinity of myoglobin for oxygen would not prevent oxygen from being taken from the blood.	
(B)	This option is incorrect. The fact that myoglobin has a high affinity for oxygen retards anaerobic respiration in the muscles.	
(C)	This option is incorrect. The increased availability of oxygen allows the use of glucose for energy following breakdown of glycogen by other pathways.	
(D)	This option is correct. Because myoglobin has a higher affinity for oxygen than hemoglobin, it takes oxygen from the blood into the muscles. This answer reflects the claim that the student can analyze the data to identify how molecular interactions (hemoglobin and myoglobin with O₂) affect function (binding of O₂).	

Question 54

Essential Knowledge	3.B.1: Gene regulation results in differential gene expression, leading to cell specialization.
Science Practice	7.1: The student can connect phenomena and models across spatial and temporal scales.
Learning Objective	3.18: The student is able to describe the connection between the regulation of gene expression and observed differences between different kinds of organisms.
(A)	This option is correct. Arabinose will bind with the repressor protein allowing expression of the genes controlled by the <i>ara</i> regulatory sequences. Because the genes for ampicillin resistance and GFP were inserted downstream of the regulatory sequences, these genes will be expressed and the products will cause the resultant colonies to be green under UV light. This answer indicates that the student is able to describe the connection between the regulation of gene expression and observed differences between different kinds of organisms.
(B)	This option is incorrect because the presence of ampicillin in the agar would not allow growth of bacteria without the plasmid, but those with the plasmid would not have increased GFP.
(C)	This option is incorrect because without arabinose the gene sequences downstream from the <i>ara</i> regulatory sequence would not be expressed.
(D)	This option is incorrect because ampicillin prevents colony growth in cells without the plasmid.

Question 55

Essential Knowledge	2.A.3: Organisms must exchange matter with the environment to grow, reproduce, and maintain organization.
Science Practice	4.1: The student can justify the selection of the kind of data needed to answer a particular scientific question.
Learning Objective	2.8: The student is able to justify the selection of data regarding the types of molecules that an animal, plant, or bacterium will take up as necessary building blocks and excrete as waste products.
(A)	This option is incorrect because carbon dioxide fixation is not part of the light-dependent reactions.
(B)	This option is correct. This choice correctly describes the events of the light-dependent reactions and indicates that the student can justify the selection of data regarding the types of molecules that an organism will take up as necessary building blocks.
(C)	This option is incorrect because water is not split in the Calvin cycle.
(D)	This option is incorrect because water is not split in the Calvin cycle.

Question 56

Essential Knowledge	2.A.3: Organisms must exchange matter with the environment to grow, reproduce, and maintain organization.
Science Practice	1.1: The student can create representations and models of natural or man-made phenomena and systems in the domain.
Learning Objective	2.9: The student is able to represent graphically or model quantitatively the exchange of molecules between an organism and its environment, and the subsequent use of these molecules to build new molecules that facilitate dynamic homeostasis, growth, and reproduction.
(A)	This option is incorrect because it indicates that protein is being synthesized in the absence of nitrogen before and after several weeks.
(B)	This option is correct. Without a source of nitrogen, the <i>Spirogyra</i> cannot synthesize proteins or nucleic acids, both of which contain nitrogen. This answer reflects that the student is able to represent graphically the exchange of molecules between an organism and its environment and the use of these molecules in synthesis.
(C)	This option is incorrect because it shows protein being synthesized at the same level as at the beginning of the experiment, and it shows an increase in the amount of nucleic acids.
(D)	This option is incorrect because it shows a significant increase in the amount of protein, which cannot be synthesized without a nitrogen source.

Question 57

Essential Knowledge	3.E.2: Animals have nervous systems that detect external and internal signals, transmit and integrate information, and produce responses.
Science Practice	1.1: The student can create representations and models of natural or man-made phenomena and systems in the domain.
Learning Objective	3.47: The student is able to create a visual representation of complex nervous systems to describe/explain how these systems detect external and internal signals, transmit and integrate information, and produce responses.
(A)	This option is incorrect because the action potentials would not increase due to interference from the antibody.
(B)	This option is correct because the antibody binds to the acetylcholine receptors, thus making fewer receptors on the postsynaptic neuron available for acetylcholine stimulation. This answer indicates that the student is able to interpret a visual representation of the nervous system to describe how this system integrates information to produce a response.
(C)	This option is incorrect. The number of sodium-gated channels in the muscle does not change.
(D)	This option is incorrect. Acetylcholine must bind to the receptor in order to have an effect. Unbound acetylcholine in the junction has no effect.

Question 58

Essential Knowledge	1.C.1: Speciation and extinction have occurred throughout the Earth's history.
Science Practice	4.2: The student can design a plan for collecting data to answer a particular scientific question.
Learning Objective	1.21: The student is able to design a plan for collecting data to investigate the scientific claim that speciation and extinction have occurred throughout Earth's history.
(A)	This option is incorrect because the number of fossils is not directly related to any period.
(B)	This option is correct because it indicates that a student is able to design a plan for collecting data concerning speciation and extinction throughout the Earth's history. The Devonian period prior to the Permian period did not contain vertebrates, which evolved later. Thus, an area prior to the Permian that contains a few early vertebrates would indicate the Devonian/Permian boundary, which would be an appropriate place for students to collect fossil data.
(C)	This option is incorrect because trilobites existed in the Permian, not the Devonian, period.
(D)	This option is incorrect because the rate of speciation is not related to the location of Devonian fossils.

Question 59

Essential Knowledge	4.A.3: Interactions between external stimuli and regulated gene expression result in specialization of cells, tissues, and organs.
Science Practice	1.3: The student can refine representations and models of natural or man-made phenomena and systems in the domain.
Learning Objective	4.7: The student is able to refine representations to illustrate how interactions between external stimuli and gene expression result in specialization of cells, tissues, and organs.
(A)	This option is correct because free calcium is needed for heterocyst formation. Binding the calcium will prevent cyst formation. This answer demonstrates that the student is able to refine representations to illustrate how interactions between external stimuli and gene expression result in specialization of cells.
(B)	This option is incorrect because the <i>patS</i> gene inhibits heterocyst formation, so fewer would be produced.
(C)	This option is incorrect because in an environment with abundant fixed nitrogen, heterocysts are not an advantage to the organism in that the anaerobic nitrogen-fixing enzymes are not needed.
(D)	This option is incorrect because loss of the <i>hetR</i> gene would prevent, not induce, heterocyst formation.

Question 60

Essential Knowledge	3.C.3: Viral replication results in genetic variation, and viral infection can introduce genetic variation into the hosts.
Science Practice	1.4: The student can use representations and models to analyze situations or solve problems qualitatively and quantitatively.
Learning Objective	3.30: The student is able to use representations and appropriate models to describe how viral replication introduces genetic variation in the viral population.
(A)	This option is incorrect because bacterial DNA, not protein, is transferred by the phage.
(B)	This option is incorrect because the recipient does not incorporate (add) the transduced DNA into its chromosome. The transduced DNA must recombine with the recipient DNA in order to become part of the chromosome.
(C)	This option is incorrect because recombinant DNA does not cause point mutations.
(D)	This option is correct. Transduction is the transfer of bacterial genes from one bacterium to another by bacteriophages.

Question 61

Essential Knowledge	2.D.1: All biological systems from cells and organisms to populations, communities, and ecosystems are affected by complex biotic and abiotic interactions involving exchange of matter and free energy.
Science Practice	3.2: The student can refine scientific questions.
Learning Objective	2.22: The student is able to refine scientific models and questions about the effect of complex biotic and abiotic interactions on all biological systems from cells and organisms to populations, communities, and ecosystems.
(A)	This option is incorrect because the phosphate is limiting; thus, additional nutrients would have no effect.
(B)	This option is incorrect because the addition of nitrogen, an essential plant nutrient, would not decrease the algal growth.
(C)	This option is correct because the limiting nutrient is phosphate, not nitrogen.
(D)	This option is incorrect because adding nitrogen, an essential plant nutrient, would not increase then decrease the algal growth.

Question 62

Essential Knowledge	2.A.2: Organisms capture and store free energy for use in biological processes.
Science Practice	3.1: The student can pose scientific questions.
Learning Objective	2.4: The student is able to use representations to pose scientific questions about what mechanisms and structural features allow organisms to capture, store, and use free energy.
(A)	This option is correct because both diagrams indicate that hydrogen ions are flowing back down their gradient through a channel in the transmembrane protein (ATP synthase) to phosphorylate ADP, forming ATP.
(B)	This option is incorrect because neither diagram shows the changes of energy to drive the electron transport chain in both processes.
(C)	This option is incorrect because neither diagram indicates temperature data needed to pose this scientific question.
(D)	This option is incorrect because neither diagram indicates data regarding evolutionary relationships needed to pose this scientific question.

Question 63

Essential Knowledge	3.B.2: A variety of intercellular and intracellular signal transmissions mediate gene expression.
Science Practice	1.4: The student can use representations and models to analyze situations or solve problems qualitatively and quantitatively.
Learning Objective	3.23: The student can use representations to describe mechanisms of the regulation of gene expression.
(A)	This option is incorrect because creating a molecule similar to the Hedgehog protein and activating Ptc will amplify the signaling pathway, possibly creating more pancreatic cancer cells.
(B)	This option is incorrect because there is no indication or data in the information provided that embryonic cells can be used to bind to other cancer cells, which will alter the Hedgehog signaling pathway.
(C)	This option is correct because inactivating Smo will modify the Hedgehog signaling pathway, thus reducing the risk of developing pancreatic cancer cells.
(D)	This option is incorrect because inducing Ci for gene transcription may cause more cancer cells to appear.

Information for Grid-In Questions 1–6

Question 1

Essential Knowledge	1.A.1: Natural selection is a major mechanism of evolution.
Science Practice	2.2: The student can apply mathematical routines to quantities that describe natural phenomena.
Learning Objective	1.3: The student is able to apply mathematical methods to data from a real or simulated population to predict what will happen to the population in the future.
<p>The correct answer is 340–360. The graph depicts a logistic growth curve for a population. The formula to calculate the per capita rate increase between days 3 and 5 is $\Delta N/\Delta T$, where ΔN=change in population size and ΔT=time interval. In other words, $\Delta N/\Delta T = 900 \text{ individuals} - 200 \text{ individuals} / 2 \text{ days} = 700 \text{ individuals} / 2 \text{ days}$. However, the mean rate of population growth is for 1 day, or 350 individuals/day.</p>	

Question 2

Essential Knowledge	3.A.3: The chromosomal basis of inheritance provides an understanding of the pattern of passage (transmission) of genes from parent to offspring.				
Science Practice	2.2: The student can apply mathematical routines to quantities that describe natural phenomena.				
Learning Objective	3.14: The student is able to apply mathematical routines to determine Mendelian patterns of inheritance provided by data.				
<p>The correct answer is 5.3–5.4. If the purple-flowered parent was heterozygous for the trait (Pp) and the other parent had yellow flowers (pp), the EXPECTED ratios for the cross $Pp \times pp$ is 1 purple-flowered: 1 yellow-flowered. From 146 offspring, 73 would be expected to have purple flowers (Pp), and 73 would be expected to have yellow flowers (pp). However, the OBSERVED offspring values from the cross were 87 purple (Pp) and 59 yellow (pp). These values can be put in a chart as follows:</p>					
Phenotype	Observed (o)	Expected (e)	(o-e)	(o-e) ²	(o-e) ² / e
Purple flowers	87	73	(87-73=14)	(14) ² =196	196/73=2.68
Yellow flowers	59	73	(59-73=-14)	(-14) ² =196	196/72=2.68
<p>The chi-square formula is $X^2 = \sum (o-e)^2 / e$, or, for this cross, $2.68 + 2.68 = 5.36$ for the null hypothesis. The critical value for $p=0.05$ with one degree of freedom is 3.84. Since 5.36 is greater than 3.84, the null hypothesis that the purple parent was heterozygous for the flower-color gene is rejected.</p>					

Question 3

Essential Knowledge	4.A.6: Interactions among living systems and with their environment result in the movement of matter and energy.
Science Practice	2.2: The student can apply mathematical routines to quantities that describe natural phenomena.
Learning Objective	4.14: The student is able to apply mathematical routines to quantities that describe interactions among living systems and their environment that result in the movement of matter and energy.
<p>The correct answer is 26 or 25. The problem is an application of the first law of thermodynamics, not the “10 percent rule” of energy transformation. To work this problem, all numbers should be converted to the same KJ/m². There are TWO possible ways to arrive at the correct answer.</p> <p>First, 14,100 KJ/m² is 74.3 percent of the total accumulated biomass, so the shrubs would possess 25.7 percent of the total biomass.</p> <p>A more complex pathway to the same answer is as follows: Energy accumulated as biomass is 1.9×10^4 KJ/m² or 19,000 KJ/m² and is distributed among the tree layer, shrub layer, and herb layer. The energy accumulated as biomass in the tree layer is 1.3×10^4 KJ/m² or 13,000 KJ/m², and the energy accumulated as biomass in the herb layer is 1.1×10^3 KJ/m² or 1,100 KJ/m². Together, the energy accumulated as biomass in the tree and herb layers is 13,000 + 1,100 KJ/m². Subtracting this amount from the total of 19,000 KJ/m² leaves 4,900 KJ/m² energy accumulated as biomass (“tied up”) in the shrub layer. This percentage of the total can be calculated as $4,900 \text{ KJ/m}^2 / 19,000 \text{ KJ/m}^2 = .257$ or 25.7 percent.</p>	

Question 4

Essential Knowledge	1.A.1: Natural selection is a major mechanism of evolution.
Science Practice	2.2: The student can apply mathematical routines to quantities that describe natural phenomena.
Learning Objective	1.1: The student is able to convert a data set from a table of numbers that reflects a change in the genetic makeup of a population over time and apply mathematical methods and conceptual understandings to investigate the cause(s) and effect(s) of this change.
<p>The correct answer for the frequency of the green allele is 0.34–0.35. After the drought, the frequency of the recessive phenotype, q^2, was 0.12. Since the population is now in Hardy-Weinberg equilibrium, the frequency of alleles will not change, so q is the square root of 0.12, or 0.35.</p>	

Question 5

Essential Knowledge	4.A.5: Communities are composed of populations of organisms that interact in complex ways.
Science Practice	2.2: The student can apply mathematical routines to quantities that describe natural phenomena.
Learning Objective	4.12: The student is able to apply mathematical routines to quantities that describe communities composed of populations of organisms that interact in complex ways.
<p>The correct answer could be any value from 1.4–1.7 months. Note: The data are reflective of actual data. To calculate the lag time in months between the change in the densities of the prey and the predator populations, calculate the differences between the prey and predator peaks or valleys. The first peak of oscillation is the prey at 4.8 months; the predator hits the first peak at approximately 6.5 months. The first valley of oscillation is the prey at 8.5 with the second at 10. When calculating the difference between lag time, subtract 8.5 from 10 to obtain 1.5 months.</p>	

Question 6

Essential Knowledge	4.A.6: Interactions among living systems and with their environment result in the movement of matter and energy.
Science Practice	2.2: The student can apply mathematical routines to quantities that describe natural phenomena.
Learning Objective	4.14: The student is able to apply mathematical routines to quantities that describe interactions among living systems and their environment that result in the movement of matter and energy.
<p>The correct answer is 60. The herbivores receive 125 g/m^2 from the grass. 60 g/m^2 is lost to decomposers, and 5 g/m^2 is lost to predators. $125 - 60 - 5 = 60 \text{ g/m}^2$ left for the herbivores to use in metabolic activity.</p>	

Answers to Multiple-Choice Questions

1 - C	17 - A	33 - B	49 - A
2 - C	18 - A	34 - A	50 - D
3 - A	19 - C	35 - D	51 - C
4 - A	20 - C	36 - A	52 - A
5 - C	21 - B	37 - D	53 - D
6 - D	22 - B	38 - B	54 - A
7 - C	23 - C	39 - A	55 - B
8 - A	24 - D	40 - C	56 - B
9 - B	25 - B	41 - A	57 - B
10 - B	26 - A	42 - A	58 - B
11 - A	27 - B	43 - B	59 - A
12 - B	28 - D	44 - C	60 - D
13 - C	29 - C	45 - B	61 - C
14 - C	30 - A	46 - A	62 - A
15 - A	31 - B	47 - C	63 - C
16 - D	32 - C	48 - D	

Answers to Grid-In Questions

1 - 340-360	4 - 0.34-0.35
2 - 5.3-5.4	5 - 1.4-1.7
3 - 26 or 25	6 - 60

Free-Response Section

Section II, the free-response part of the exam, begins with a mandatory 10-minute reading period. Students should read, review, and begin preliminary planning for their responses. This section contains two types of free-response questions, and the student will have a total of 80 minutes to complete all the questions.

Due to the emphasis on quantitative skills and the application of mathematical methods in the questions on both sections, students will be allowed to use simple four-function calculators (with square root) on the entire exam. Students will also be supplied with a formula list as part of their testing materials.

Information for Free-Response Question 1

<p>Essential Knowledge</p>	<p>2.A.2: Organisms capture and store free energy for use in biological processes.</p> <p>4.A.4: Organisms exhibit complex properties due to interactions between their constituent parts.</p> <p>4.A.5: Communities are composed of populations of organisms that interact in complex ways.</p> <p>4.A.6: Interactions among living systems and with their environment result in the movement of matter and energy.</p> <p>4.C.4: The diversity of species within an ecosystem may influence the stability of the ecosystem.</p>
<p>Science Practices</p>	<p>6.2: The student can <i>construct explanations of phenomena based on evidence</i> produced through scientific practices.</p> <p>6.4: The student can <i>make claims and predictions about natural phenomena</i> based on scientific theories and models.</p>
<p>Learning Objectives</p>	<p>2.5: The student is able to construct explanations of the mechanisms and structural features of cells that allow organisms to capture, store, or use free energy.</p> <p>4.9: The student is able to predict the effects of a change in the component(s) of a biological system on the functionality of the organisms(s).</p> <p>4.13: The student is able to predict the effects of a change in the community's populations on the community.</p> <p>4.16: The student is able to predict the effect of a change of matter or energy availability on the community.</p> <p>4.27: The student is able to make scientific claims and predictions about how species diversity within an ecosystem influences ecosystem stability.</p>
<p>Characteristics of a STRONG Response</p>	<p>(Part a) The student is able to write a coherent paragraph with appropriate terminology and elaboration to explain how free energy is required for living systems — from cells to populations, communities, and ecosystems — and can predict consequences to these systems if free energy needs are not met. Based on the scenario, the student is able to explain through narrative or diagram with annotation the role of the electron transport chain and its associated proteins with the production of ATP and NADPH in the light-dependent reactions of photosynthesis. The student is able to predict consequences of a viral infection that disrupts the ETS in cells and justifies those predictions <i>even though the question does not specifically ask for justification</i>. For example, the student might say that because the light-independent reactions (Calvin cycle) require ATP and NADPH generated in the ETS of the light-dependent reactions, if one of the ETS proteins is disrupted by a virus, production of ATP and/or NADPH decreases and the cells will be unable to fix carbon into G3P. In turn, cellular respiration, which depends on carbohydrate produced in the Calvin cycle, likely decreases. The student is able to make connections between concepts — in this case, the interdependency of the light-dependent and light-independent reactions of photosynthesis, and photosynthesis and cellular respiration.</p>

	<p>(Part b) The student is able to identify, explain, or describe several consequences of viral infection on individual plants and provide justification. Predictions may include, but are not limited to, stunted growth due to lack of energy needed for building molecules; inability to grow, repair tissues, and reproduce due to lack of usable free energy; and likelihood of the plant weakening or dying if energy demands cannot be met once the plant uses up pre-infection energy stores.</p> <p>(Part c) The student is able to explain how a change in one component (e.g., virus, plant species) of a biological system (e.g., plant, prairie community) affects the community as a whole with respect to matter and energy flow. The student is able to predict several potential effects — both negative and positive — of short-term change due to a viral infection on the plant population and prairie community and justify those predictions. For example, the student may explain how a virus that infects a population of producers (i.e., grass species) could result in a decrease in consumer population size as less energy is available for the higher trophic levels. Similarly, the student may explain how the reproductive rate in uninfected plants likely increases due to more available resources with the death of infected plants.</p> <p>(Part d) The student is able to predict several potential effects — both negative and positive — of long-term change due to a viral infection on the plant population and prairie community and justify those predictions. For example, the student may explain how the loss of infected plants reduces genetic variability of the grass species, or may describe how the loss of prairie grass increases erosion, resulting in degradation of the abiotic environment. Similarly, the student may predict with justification how changes in allele frequencies in the infected plants lead to natural selection and evolution or that if the affected grass is replaced by other plant species, the long-term effects can be minimized. Based on considerations, the student is able to explain how populations and communities with species diversity (e.g., a prairie) are more stable and better able to withstand changes to the environment.</p>
<p>Characteristics of a GOOD Response</p>	<p>(Part a) With less elaboration, the student is able to write a coherent paragraph to explain why all organisms require free energy and matter to survive and identifies photosynthesis as an energy-producing strategy associated with plants, including prairie grass. The student is able to explain through narrative or diagram with annotation the general process of the electron transport chain and its associated proteins and its role in the production of energy in light-dependent reactions of photosynthesis. The student identifies ATP and NADPH as energy-carrying molecules. The student is able to predict two to three consequences of a virus that acts by disrupting the ETS. Possible consequences that the student may cite include less ATP and NADPH produced because these energy-carriers are produced in the ETS, and decreased O₂ production if photosynthesis grinds to a halt. Justifications are more limited.</p>

	<p>(Part b) The student is able to identify, explain, or describe two to three consequences of viral infection on individual plants and justify the predictions. However, justifications are more limited. Predictions may include, but are not limited to, stunted growth due to lack of energy needed for building molecules; the inability to grow, repair tissues, and reproduce due to lack of usable free energy; and plant death if energy demands cannot be met.</p> <p>(Part c) The student is able to explain how a change in the plant population due to infection affects the prairie community as a whole with respect to energy flow/dynamics. The student is able to predict two to three consequences of short-term change due to a viral infection on the plant population and prairie community and justify the predictions. However, justifications are more limited. For example, the student may describe how the population size decreased due to death of infected members, or that the herbivore population could decrease due to increased competition for resources. Similarly, the student may describe how unaffected plant species gain resources because the loss of infected plants leads to more available resources.</p> <p>(Part d) The student is able to predict two to three potential effects — both negative and positive — of long-term change due to a viral infection on the plant population and prairie community and justify those predictions. However, justifications are more limited. For example, the student may describe how plant species become locally extinct due to increased death rate attributed to infection. Similarly, the student could predict a change in allele frequency when naturally resistant phenotypes are selected for. Based on the considerations, the student is able to explain how populations and communities with species diversity (e.g., a prairie) are better able to withstand change to the environment.</p>
<p>Characteristics of a WEAK Response</p>	<p>(Part a) The student's narrative is less coherent and often lacks correct terminology. The student is able to state that organisms require free energy to survive but is limited in ability to explain <i>why</i> free energy is necessary. The student identifies photosynthesis as an energy-producing process in plants and can list ATP (and possibly NADPH) as an energy-carrying molecule(s) produced in photosynthesis. However, the student's explanation of how the electron transport chain produces energy in the form of ATP (and/or NADPH) is limited and reflects little conceptual understanding on the molecular level. The student is able to predict one to two consequences of a virus that acts by disrupting the ETS but cannot elaborate on the reasons (justifications) for the disruption(s).</p> <p>(Part b) The student is able to describe one to two consequences of viral infection on individual plants but cannot justify the predictions. For example, the student states that the infected plant can die but does not give a reason for the consequence.</p>

	<p>(Part c) The student is able to explain how a decrease in the amount of grass due to infection affects the energy dynamics of the prairie community; that is, a change in the producer trophic level affects the consumer level(s). The student is able to describe 1–2 adverse consequences of short-term change due to infection on the plant population and prairie community but provides limited or no justification for the predictions. The student likely does not consider possible positive effects to the prairie community.</p> <p>(Part d) The student is able to predict one to two adverse consequences of long-term change due to infection on the plant population and prairie community but provides limited or no justification for the predictions. The student likely does not consider possible positive effects on the community and is unable to explain with much coherence why populations and communities with species diversity (e.g., a prairie) are better able to withstand change to the environment.</p>
--	--

Scoring Guidelines for Free-Response Question 1

<p>10 points maximum; 1 point for each specific prediction. A maximum of 3 points can be earned in any one section.</p>
<p>(Part a) 1 point for each reasonable resulting change to a cellular process. Effects may include:</p> <ul style="list-style-type: none">• Less ATP produced.• Less NADPH produced.• Inability to fix carbon via Calvin cycle without products of electron transport chain.• Decrease in O₂ production.
<p>(Part b) 1 point for each reasonable expected change to an individual plant, with explanation. Explanations may include:</p> <ul style="list-style-type: none">• Plant cannot produce glucose due to decrease in photosynthetic product (G3P).• Stunted growth due to lack of energy for building molecules.• Plant becomes weakened and may die due to lack of ability to capture energy.• Plant uses up pre-infection energy stores.• Cannot perform growth/repair/reproduction due to lack of usable energy.
<p>(Part c) 1 point for each reasonable predicted short-term change to the plant population or the prairie community, with justification. Predictions may include:</p> <ul style="list-style-type: none">• Reduction in population size of affected prairie grass due to death of infected members.• Decrease in consumer population size as less energy available for the higher trophic levels.• Smaller herbivore population size due to increased competition for limited resources.• Unaffected plant species gain resources due to loss of infected plants.• Uninfected plants have increased offspring due to more available resources.
<p>(Part d) 1 point for each reasonable predicted long-term change to the plant population or the prairie community, with justification. Predictions may include:</p> <ul style="list-style-type: none">• Plant species becomes locally extinct.• Reduction in genetic variability due to loss of infected plants.• Change in allele frequencies for the affected species.• Loss of consumer species dependent on affected prairie grass species.• Members of the affected species with a genotype conferring resistance become more common, leading to no long-term effects to the population or community.• Grass is replaced by other species — community is stabilized, or some changes in members of the food chain.• Increased erosion due to lack of grass leading to degradation of abiotic environment, further limiting the ability of the environment to support the community.

Information for Free-Response Question 2

Essential Knowledge	4.A.6: Interactions among living systems and with their environment result in the movement of matter and energy.
Science Practices	1.4: The student can <i>use representations and models</i> to analyze situations or solve problems qualitatively and quantitatively. 2.2: The student can <i>apply mathematical routines</i> to quantities that describe natural phenomena.
Learning Objectives	4.14: The student is able to apply mathematical routines to quantities that describe interactions among living systems and their environment, which result in the movement of matter and energy. 4.15: The student is able to use visual representations to analyze situations or solve problems qualitatively to illustrate how interactions among living systems and with their environment result in the movement of matter and energy.
Characteristics of a STRONG Response	<p>The student is capable of demonstrating understanding that interactions among living systems and with their environment result in the movement of matter and energy.</p> <p>(Part a) The student is able to draw a graph showing the effect of temperature change on the rate of transpiration that possesses properly labeled and scaled axes with points accurately plotted. The student may either connect the points or construct an accurate best-fit line. The student is able to write a coherent paragraph with appropriate terminology and elaboration to explain that the shape of the curve from 23–28 degrees demonstrates that the rate of evaporation increases with increasing temperature and/or that at higher temperatures there are more open stomata. The student also recognizes the leveling off of the line and is able to explain that as the temperature rises too high the plant begins to close its stomata to prevent excessive water loss.</p> <p>(Part b) The student is able to draw a curve that possesses properly labeled and scaled axes indicating a measure of humidity. The student then explains this decreasing curve to the fact that increasing humidity leads to reduced evaporation rates due to a decreased difference in water vapor pressure between the leaf and the atmosphere.</p> <p>(Part c) The student can use the graph, a representation of the effect of increasing percentage of open stomata per area of leaf on the rate of transpiration. The student recognizes and is able to articulate an understanding of the difference in rates of transpiration from 0–60 percent open stomata compared to 60 percent–100 percent open stomata. The student articulates understanding that as the number of open stomata increases, the rate of diffusion between the leaf interior and the environment will increase, and therefore the transpiration rate also increases. The student is then able to recognize that above 60 percent open stomata there must be another limiting factor, such as no difference in vapor pressure between the leaf interior and the environment. Transpiration is now limited by humidity.</p>

	<p>(Part d) The student is able to articulate the understanding that an adaptation is a trait that an organism possesses that increases its fitness within its niche. The student demonstrates an understanding of structure and function by correctly connecting the organism to its environment. The student justifies that Anacharis must be adapted to an environment where transpiration does not occur, such as underwater or in 100 percent humidity because in either environment there would be no need for stomata. The student successfully connects all stomata on the upper epidermis to the water lily and justifies this to the water lilies' environment on the surface of water. The student justifies the large number of stomata as the plant's increasing its ability for gas exchange with no danger of excess water loss due to its environment. Lastly, the student connects the presence of stomata, limited to the lower leaf surface, to an understanding that black walnut is adapted to an environment where the upper surface is exposed to strong sunlight and higher temperatures and/or where water is more limited compared to an aquatic environment. Stomata located on the lower epidermis of leaves are shaded from exposure to direct sunlight and higher temperatures, mitigating excessive water loss.</p>
<p>Characteristics of a GOOD Response</p>	<p>(Part a) The student is able to draw a graph showing the effect of temperature change on the rate of transpiration that possesses properly labeled and scaled axes with points accurately plotted. The student may either connect the points or construct an accurate best-fit line. The student is able to write a coherent paragraph with appropriate terminology and elaboration to explain that the shape of the curve from 23–28 degrees demonstrates that the rate of evaporation increases with increasing temperature and/or that at higher temperatures there are more open stomata. The student also recognizes the leveling off of the line and is able to explain that as the temperature rises too high, the plant begins to close its stomata to prevent excessive water loss.</p> <p>(Part b) The student is able to properly draw a curve that possesses properly labeled and scaled axes indicating a measure of humidity. The student is unable to explain that the decreasing curve is due to the fact that increasing humidity leads to reduced evaporation rates due to a decreased difference in water vapor pressure between the leaf and the atmosphere but can explain generically that water does not evaporate as readily in high humidity.</p>

	<p>(Part c) The student can use the graph, a representation of the effect of increasing percentage of open stomata per area of leaf on the rate of transpiration. The student recognizes and is able to articulate an understanding of the difference in rates of transpiration from 0–60 percent open stomata compared to 60 percent–100 percent open stomata. The student articulates the understanding that as the number of open stomata increases, the rate of diffusion between the leaf interior and the environment will increase, and therefore the transpiration rate also increases. The student is unable to recognize that above 60 percent open stomata there must be another limiting factor, such as no difference in vapor pressure between the leaf interior and the environment.</p> <p>(Part d) The student is able to articulate the understanding that an adaptation is a trait that an organism possesses that increases its fitness within its niche. The student demonstrates an understanding of structure and function by correctly connecting the organism to its environment but has difficulty with justifications.</p>
<p>Characteristics of a WEAK Response</p>	<p>(Part a) The student is able to draw a graph showing the effect of temperature change on the rate of transpiration that possesses properly labeled and scaled axes with points accurately plotted. The student may either connect the points or construct an accurate best-fit line. The student is able to write a coherent paragraph with appropriate terminology to explain that the shape of the curve from 23–28 degrees demonstrates that the rate of evaporation increases with increasing temperature and/or that at higher temperatures there are more open stomata.</p> <p>(Part b) The student is able to properly draw a curve that possesses properly labeled and scaled axes indicating a measure of humidity. The student is unable to explain the decreasing curve to the fact that increasing humidity leads to reduced evaporation rates due to a decreased difference in water vapor pressure between the leaf and the atmosphere.</p> <p>(Part c) The student can read the graph, a representation of the effect of increasing percentage of open stomata per area of leaf on the rate of transpiration. The student recognizes but is unable to articulate an understanding of the difference in rates of transpiration from 0–60 percent open stomata compared to 60 percent–100 percent open stomata. The student articulates the understanding that as the number of open stomata increases, the rate of transpiration increases but does not demonstrate the understanding that the rate of diffusion between the leaf interior and the environment will increase, and therefore the transpiration rate increases. The student is unable to recognize that above 60 percent open stomata there must be another limiting factor, such as no difference in vapor pressure between the leaf interior and the environment.</p> <p>(Part d) The student is able to connect one of the organisms to an environment, such as water lilies to a body of water but is unable to justify the decision or is very general in the justifications.</p>

Scoring Guidelines for Free-Response Question 2

10 points maximum; students must earn points in each part of the question to receive all 10 points.

(Part a) Up to 3 points for a properly drawn graph.

One point for each of the following:

- Axes properly labeled and scaled
- Points properly plotted
- Correctly drawing either the curve with connected points or the best-fit line

NOTE: The student may use full scale (0–30), limited scale (20–30), or other legitimate scaling of the x-axis. Two examples are shown. The solid lines indicate the curve with connected points, and the dashed lines indicate the best-fit line.

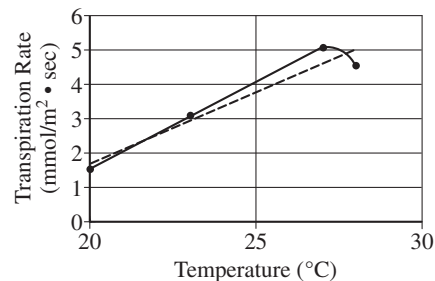
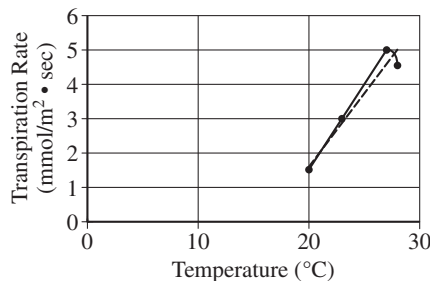

1 point for an appropriate description of the shape of the curve:

- Drawn curve shows increasing rate of transpiration from 20 to 27 degrees and reduction in transpiration rate from 27 to 28 degrees; or
- Best-fit curve shows steady increase in transpiration correlated to increase in temperature.

1 point for appropriate explanation of the change:

- Rate of water evaporation increases with increasing temperature.
- As temperature increases there are more open stomata.
- At the higher temperature stomata begin to close.
- Plants open and close stomata in response to environmental conditions.

(Part b) 1 point for a properly drawn curve, as shown, with correct axes and labels. The curve must have some indication of humidity measure, e.g., 0–100.

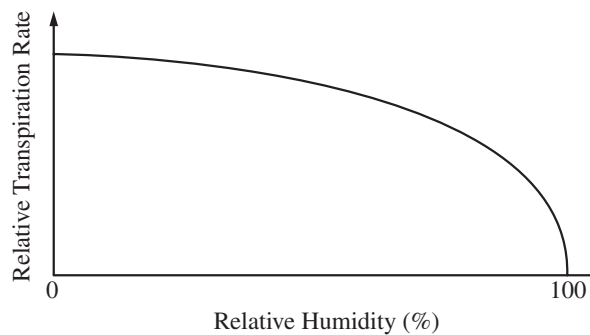

1 point for a correct explanation:

- Increasing humidity leads to reduced evaporation rates due to decreased difference in water vapor pressure (water potential) between leaf and atmosphere.

(Part c) 1 point for a correct explanation of the increase in transpiration rate from 0 to 60 percent of open stomata:

- From 0 to 60 percent open stomata, there is an increase in gas exchange with more stomata open.
- There is higher rate of diffusion between the leaf interior and the environment with more stomata open.

1 point for a correct explanation of the flattening of the curve when more than 60 percent of stomata are open:

- When more than 60 percent of the stomata are open, another factor becomes limiting.
- Rate of water movement is now limiting.
- Transpiration is now limited by humidity.

(Part d) Up to 3 points for a reasonable description of each environment, with an appropriate justification.

Descriptions may include:

- Anacharis is adapted to an environment where transpiration does not occur, such as underwater or in 100 percent humidity. There is no need for water vapor *or* it cannot occur via transpiration.
- Water lilies are adapted to an environment where only the upper side of the leaf is exposed to air; thus, only one surface can exchange water vapor with the environment. The large number of stomata is not a disadvantage because the plant has easy access to water.
- Black walnut is adapted to an environment where the upper surface is exposed to strong sunlight and higher temperatures and/or where water is more limited compared to a watery environment. Stomata located on lower epidermis of leaves are shaded from exposure to direct sunlight and higher temperatures, mitigating excessive water loss.

Information for Free-Response Question 3

Essential Knowledge	1.A.4: Biological evolution is supported by scientific evidence from many disciplines, including mathematics.
Science Practices	1.1: The student can <i>create representations and models</i> of natural or man-made phenomena and systems in the domain. 2.1: The student can <i>justify the selection of a mathematical routine</i> to solve problems.
Learning Objectives	1.13: The student is able to construct and/or justify mathematical models, diagrams, or simulations that represent processes of biological evolution.
Characteristics of a STRONG Response	<p>(Part a) The student is able write a coherent paragraph with appropriate terminology to correctly explain that p^2 represents the frequency (proportion, percent) of the homozygous straight-wing individuals and that each has two copies of the dominant allele. The student also can correctly explain that q^2 represents the frequency (proportion, percent) of the homozygous curly-wing individuals and that each has two copies of the recessive allele. Finally, the student can correctly explain that $2pq$ represents the frequency (proportion, percent) of the heterozygous straight-wing flies and that each has one copy of the dominant allele and one copy of the recessive allele.</p> <p>(Part b) The student is able write a coherent paragraph with appropriate terminology to correctly describe one of the following conditions: large population size, no selection, no mutation, no migration, random mating. Descriptions show an understanding that:</p> <ul style="list-style-type: none"> • Large populations decrease the role of chance fluctuations in allele frequencies that occur more often in smaller populations. This is referred to as genetic drift. • No natural selection ensures no differential survival or reproductive success of individuals carrying different genotypes that would alter allele frequencies. • No mutations ensures no introduction or removal of genes from chromosomes or changes to the genes and thus the gene pool. • No migration or gene flow ensures no transfers of alleles between populations that would alter allele frequencies. • Random mating ensures random mixing of the gametes and no preference to certain genotypes.
Characteristics of a GOOD Response	<p>(Part a) The student is able write a coherent paragraph with appropriate terminology to correctly explain two out of the three terms.</p> <p>(Part b) The student is able write a coherent paragraph with appropriate terminology to correctly describe one of the following conditions: large population size, no selection, no mutation, no migration, random mating.</p>

<p>Characteristics of a WEAK Response</p>	<p>(Part a) The student is able write a coherent paragraph with appropriate terminology to correctly explain one of the terms.</p> <p>(Part b) The student is able write a coherent paragraph with appropriate terminology to correctly describe one of the following conditions: large population size, no selection, no mutation, no migration, random mating.</p>
--	--

Scoring Guidelines for Free-Response Question 3

<p>4 points maximum.</p>
<p>(Part a) Up to 3 points for the following correct explanations:</p> <ul style="list-style-type: none"> • p^2 represents the frequency (proportion, percent) of the homozygous straight-wing individuals; each has two copies of the dominant allele. • $2pq$ represents the frequency (proportion, percent) of the heterozygous straight-wing flies; each has one copy of the dominant allele and one copy of the recessive allele. • q^2 represents the frequency (proportion, percent) of the homozygous curly-wing individuals; each has two copies of the recessive allele.
<p>(Part b) 1 point for a correct description of a condition:</p> <ul style="list-style-type: none"> • Correct descriptions of a condition include: large population size, no selection, no mutation, no migration, and random mating.

Information for Free-Response Question 4

Essential Knowledge	1.C.2: Speciation may occur when two populations become reproductively isolated from each other.
Science Practice	4.1: The student can <i>justify the selection of the kind of data</i> needed to answer a particular scientific question.
Learning Objective	1.23: The student is able to justify the selection of data that address questions related to reproductive isolation and speciation.
Characteristics of a STRONG Response	(Parts a and b are combined.) The student is able write a coherent paragraph with appropriate terminology to correctly identify two kinds of data that could be collected. For each of the data, the student explains with justification how the selection of the data addresses the question of whether the populations growing above 2,500 meters and the populations growing below 2,300 meters represent a single species. Given the scenario, the student is able to identify that the plant populations have the potential to interbreed in nature and produce viable and/or fertile offspring. The student is also able to identify that the two plant populations may have the ability to cross-pollinate and/or germinate seeds, as another appropriate type of data. For any of these data sets, the student then validates his or her choice of the data by stating that the biological species concept supports these data. The student may also be able to identify that when comparing the DNA or conserved proteins, a sufficient number of similarities between the two plant species may justify that the two populations may be the same species.
Characteristics of a GOOD Response	The student is able to describe two kinds of data but may be able to justify the selection of only one as answering the question of whether the two populations are the same species. Such an answer would indicate understanding of the biological definition of species.
Characteristics of a WEAK Response	The student may be able to describe two kinds of data without justification, or may be able to correctly describe and justify only one kind of data. This student would indicate limited knowledge of the biological definition of a species.

Scoring Guidelines for Free-Response Question 4

4 points maximum.

Description of the appropriate kind of data and the appropriately linked explanation of its selection may include:

Description of kind of data (1 point each)	Explanation (1 point each)
Ability to produce viable seeds/offspring in nature	Consistent with definition of biological species
Ability to cross-pollinate	Consistent with definition of biological species
Production of fertile offspring	Consistent with definition of biological species
Comparison of sequence of DNA or structures of other conserved molecules	Sufficient similarity supports single species
Comparison of chromosome number and/or structure	Similarity supports single species
Fertile hybrid populations found living between the two other populations of plants	Consistent with definition of biological species

Information for Free-Response Question 5

Essential Knowledge	2.B.3: Eukaryotic cells maintain internal membranes that partition the cell into specialized regions.
Science Practice	6.2: The student can <i>construct explanations of phenomena based on evidence</i> produced through scientific practices.
Learning Objective	2.13: The student is able to explain how internal membranes and organelles contribute to cell functions.
Characteristics of a STRONG Response	<p>Attached ribosome (location and function): The student is able to write a coherent paragraph with appropriate terminology and elaboration to explain how a protein produced on the <u>attached ribosome</u> may ultimately end up as a secretory protein excreted from the cell for further use by another cell for cell signaling, signal transduction, or a particular type of metabolic action. Students may also say that the protein may end up embedded into the cell membrane as an integral protein or peripheral protein. The student could then elaborate on how this receptor protein can help in membrane signaling or as an enzyme in a metabolic reaction. The student may mention that the secretory proteins may also be found in transport vesicles for further processing in the Golgi apparatus or to other components of the endomembrane system. The student may mention that proteins end up inside a vacuole or as a digestive enzyme or are stored for later use in seed plants. Another possible description is that the proteins end up inside the Golgi apparatus. The protein will eventually be packed and excreted as a transmembrane protein within the cell.</p> <p>Free ribosome (location and function): The student is able to write a coherent paragraph with appropriate terminology and elaboration to explain how a protein produced on the <u>free ribosome</u> may ultimately end up in the cytosol or a vacuole as a structural protein to function in the cytoskeleton or as a motor protein in the cell. The student may also mention that the proteins in the vacuole function as an enzyme that mediates cell processes or as a second messenger in a cell signal transduction mechanism. Another explanation of the location of a protein is in the nucleus. The student would elaborate that the protein would function as a transcription factor or in DNA packaging in chromosomes.</p>

<p>Characteristics of a GOOD Response</p>	<p>Attached ribosome (location and function): The student is able to explain in a paragraph how a protein produced on the <u>attached ribosome</u> may ultimately end up as a secretory protein excreted from the cell for further use by another cell; however, the student will not go into further details. The student may also say that the protein may end up embedded in the cell membrane as an integral protein or as a peripheral protein. The student states that this receptor protein contributes to the structure of the cell membrane but will not provide additional details. The student may mention that the secretory proteins may also be found in transport vesicles for further processing in the Golgi apparatus or to other components of the endomembrane system. The student may mention that proteins end up inside a vacuole for storage but not explain further details of how they function for the plant being in the vacuole.</p> <p>Free ribosome (location and function): The student is able to write a paragraph to explain how a protein produced on the <u>free ribosome</u> may ultimately end up in the cytosol or a vacuole as a structural protein to function in the cytoskeleton or as a motor protein in the cell. The student may also mention that the proteins in the vacuole function as an enzyme. Also included in the explanation could be how the location of the protein in the nucleus can function as a transcription factor or with DNA.</p>
<p>Characteristics of a WEAK Response</p>	<p>The student may mention the location but not the function or vice versa, and the identifications and explanations will be brief.</p> <p>Attached ribosome (location and function): The student is able to explain how a protein produced on the <u>attached ribosome</u> may end up as a protein excreted from the cell. The student may also say that the protein may end up embedded into the cell membrane. The student may not be able to elaborate on the functions. The student may mention that the proteins are found in transport vesicles for further processing in the Golgi apparatus. The student may mention that proteins end up inside a vacuole but may not mention their function.</p> <p>Free ribosome (location and function): The student is able to explain how a protein produced on the <u>free ribosome</u> may end up in the cytosol or a vacuole. The explanation may also include factors surrounding the location of a protein in the nucleus. The student may mention that the protein has something to do with DNA but not elaborate further.</p>

Scoring Guidelines for Free-Response Question 5

4 points maximum.

Possible explanations for attached ribosomes include:

Ultimate Destination (1 point maximum)	General Function (1 point maximum)
Excreted from cell	<ul style="list-style-type: none"> • An intercellular messenger/hormone/signaling molecule • Extracellular matrix protein
Integrated into the cell membrane	<ul style="list-style-type: none"> • Surface receptor • Transmembrane transport
Inside an organelle such as a lysosome	<ul style="list-style-type: none"> • Enzyme that hydrolyzes old molecules • Digestive enzyme
Inside a Golgi apparatus	<ul style="list-style-type: none"> • Packaged into a lipoprotein or glycoprotein • Immature extracellular matrix protein

Possible explanations for free ribosomes include:

Ultimate Destination (1 point maximum)	General Function (1 point maximum)
In cytosol	<ul style="list-style-type: none"> • Structural protein in cell, such as cytoskeleton and motor proteins • Enzyme that mediates cell process • Second messenger
In a vacuole	<ul style="list-style-type: none"> • Enzyme that mediates cell process
In nucleus	<ul style="list-style-type: none"> • Transcription factor

Information for Free-Response Question 6

Essential Knowledge	3.A.3: The chromosomal basis of inheritance provides an understanding of the pattern of passage (transmission) of genes from parent to offspring.
Science Practice	2.2: The student can apply mathematical routines to quantities that describe natural phenomena.
Learning Objective	3.14: The student is able to apply mathematical routines to determine Mendelian patterns of inheritance provided by data.
Characteristics of a STRONG Response	The student is able to write a coherent paragraph that shows an understanding of independent assortment, linkage, and recombination in the transmission of genes from parent to offspring. A prediction of a 1:1:1:1 ratio will be supported by a diagram or Punnett square. The student will be able to use a chi-square analysis to show that the results of the cross do not fit the expected 1:1:1:1 ratio predicted by independent assortment and will be able to explain that the genes for body color and eye color are linked on the same chromosome. A strong student may also predict the relative location of the genes on the chromosome based on the data.
Characteristics of a GOOD Response	The student is able to write a coherent paragraph that indicates an understanding of independent assortment and linkage in the transmission of genes from parent to offspring. The student will be able to use a diagram of the cross to support a 1:1:1:1 ratio predicted by independent assortment and will be able to recognize that the eye color and body color genes are linked with some recombination. The student will be able to predict the relative location of the genes on the chromosome by recognizing the recombinant phenotypes and calculating the ratio.
Characteristics of a WEAK Response	The student is able to predict a 1:1:1:1 ratio based on independent assortment. The student may support this prediction with a Punnett square or diagram, or may recognize that the genes for eye color and body color are linked on the same chromosome.

Scoring Guidelines for Free-Response Question 6

4 points maximum.
<p>Student explanations include the following:</p> <ul style="list-style-type: none"> • Prediction of a 1:1:1:1 ratio with correct phenotypes based on independent assortment. • Support for prediction with a diagram of the cross of <i>BbEe</i> x <i>bbee</i>. • Correct application of chi-square analysis to show that observed results do not conform to expected Mendelian frequencies. • Identification of body color and eye color as linked genes/loci. • Use of ratios to show linkage and independent assortment of wing type versus linked traits. • Identification of the bottom two phenotypes as products of crossing over (recombinant chromosome). • Mentioning that crossover rate is approximately 9–10 percent.

Information for Free-Response Question 7

Essential Knowledge	2.D.1: All biological systems from cells and organisms to populations, communities, and ecosystems are affected by complex biotic and abiotic interactions involving exchange of matter and free energy.
Science Practice	5.1: The student can analyze data to identify patterns or relationships.
Learning Objective	2.24: The student is able to analyze data to identify patterns and relationships between a biotic or abiotic factor and a biological system (cells, organisms, populations, communities, or ecosystems).
Characteristics of a STRONG Response	The student is able to explain three possible factors that influence the shape of the growth pattern. The student will correctly identify and explain the logarithmic pattern of period 1 and the slowing of the growth rate in period 2 and will relate each specific biological factor to the change in growth rate of the system.
Characteristics of a GOOD Response	The student is able to explain two factors that influence the shape of the growth pattern, correctly explaining the logarithmic growth in period 1 and how each factor causes a slowing of the growth rate in period 2.
Characteristics of a WEAK Response	The student is able to relate one possible factor to the shape of the growth pattern, correctly explaining the logarithmic growth in period 1 and how that factor causes a slowing of the growth in period 2.

Scoring Guidelines for Free-Response Question 7

<p>3 points maximum. 1 point for each correct explanation of the pattern or relationship between the environmental factor and the biological system.</p>
<p>Possible explanations include the following:</p> <ul style="list-style-type: none"> • Recognition of exponential growth due to lack of limiting factors; reproductive/growth rate far exceeds death rate. • Slowing of reproductive/growth rate due to the influence of density-dependent limiting factors. • Death rate beginning to approach reproductive/growth rate in transition from period 1 to period 2. • Accumulation of toxic wastes increases death rate and decreases reproductive rate. • Population at carrying capacity stabilizes as the reproductive rate equals the death rate.

Information for Free-Response Question 8

Essential Knowledge	1.D.1: There are several hypotheses about the natural origin of life on Earth, each with supporting scientific evidence. 2.A.2: Organisms capture and store free energy for use in biological processes.
Science Practices	3.3: The student can <i>evaluate scientific questions</i> . 6.2: The student can <i>construct explanations of phenomena based on evidence</i> produced through scientific practices.
Learning Objectives	1.28: The student is able to evaluate scientific questions based on hypotheses about the origin of life on Earth. 2.5: The student is able to construct explanations of the mechanisms and structural features of cells that allow organisms to capture, store, or use free energy.
Characteristics of a STRONG Response	A strong student will be able to identify a microbe as photosynthetic if it had evidence of photosynthetic pigments or a photosynthetic membrane within the cell. The student will also indicate that the presence of oxides or oxygen gas in the surrounding rock provides such evidence. Conversely, the student may state that the lack of photosynthetic structures or evidence of oxygen would suggest this microbe was not photosynthetic.
Characteristics of a GOOD Response	A good student would be able to cite one piece of evidence indicating whether or not the microbe was photosynthetic, such as the presence of photosynthetic pigments or membrane. The student may instead choose to use evidence of oxygen or oxides in the surrounding rock or to state that their absence indicates that the organism was not photosynthetic.

Scoring Guidelines for Free-Response Question 8

2 points maximum.
<p>Possible evidence that the organism was photosynthetic:</p> <ul style="list-style-type: none"> • Internal presence of photosynthetic membrane or chloroplast • High levels of oxygen gas or oxides in the surrounding rock • Evidence of photosynthetic pigments in cell • Chemical analysis of the fossil shows the presence of molecules associated with the photosynthetic process <p>Possible evidence that the organism was not photosynthetic:</p> <ul style="list-style-type: none"> • Lack of photosynthetic membrane or chloroplast • Surrounding rock suggests anaerobic environment

Contact Us

AP Services
P.O. Box 6671
Princeton, NJ 08541-6671
609-771-7300
888-225-5427 (toll free in the U.S. and Canada)
610-290-8979 (Fax)
Email: apexams@info.collegeboard.org

National Office
45 Columbus Avenue
New York, NY 10023-6992
212-713-8000

AP Canada Office
2950 Douglas Street, Suite 550
Victoria, BC, Canada V8T 4N4
250-472-8561
800-667-4548 (toll free in Canada only)
Email: gewonus@ap.ca

International Services
Serving all countries outside the U.S. and Canada
45 Columbus Avenue
New York, NY 10023-6992
212-373-8738
Email: international@collegeboard.org

